

HEPATITIS WEB STUDY  HEPATITIS C ONLINE

Sofosbuvir (*Sovaldi*)

Prepared by: David Spach, MD & H. Nina Kim, MD
Last Updated: July 14, 2015

SOFOSBUVIR (*SOVALDI*)
Background and Dosing

Sofosbuvir (*Sovaldi*)

- **Approval Status:** FDA approved December 6, 2013
- **Indication for HCV Monoinfection and HCV-HIV Coinfection**
 - GT 1,4: Sofosbuvir + peginterferon + ribavirin (12 weeks)
 - GT 2: Sofosbuvir + ribavirin (12 weeks)
 - GT 3: Sofosbuvir + ribavirin (24 weeks)
- **Additional Indication for HCV Monoinfection**
 - GT 1 (interferon ineligible): Sofosbuvir + ribavirin (24 weeks)
 - HCC and awaiting transplant: Sofosbuvir + ribavirin (up to 48 weeks)
- **Class & Mechanism**
 - Nucleotide analog inhibitor of NS5B polymerase enzyme
- **Dosing:** 400 mg PO once daily with or without food
- **Adverse Effects (AE) attributable to Sofosbuvir**
 - Fatigue, headache
- **Wholesaler Acquisition Cost in United States**
 - 28 tablet bottle = \$28,000; estimated 12-week cost = \$84,000

Sofosbuvir NS5B Polymerase Inhibitor

Ingestion of
Prodrug

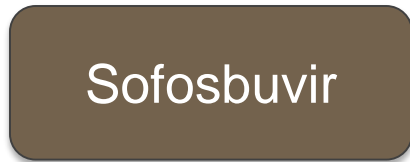

Predominant
Circulating form

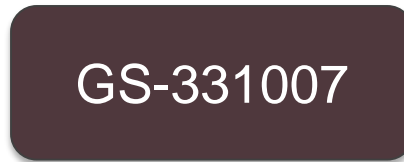

Intracellular
Active Triphosphate

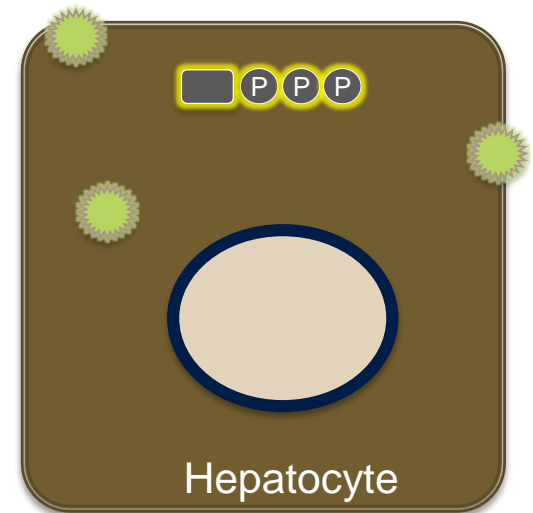
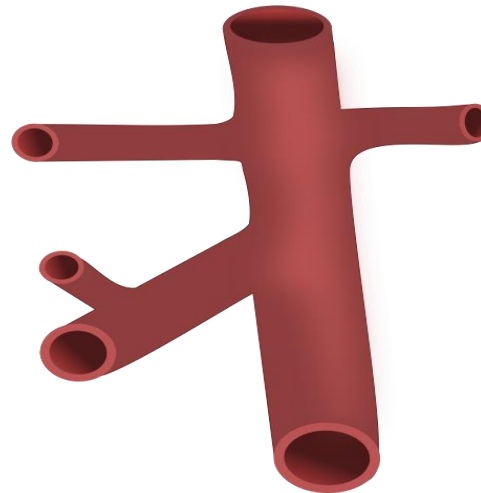
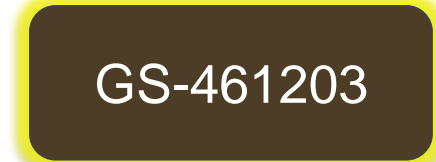

Sofosbuvir

Drug-Drug Interactions

Sofosbuvir not recommended for coadministration with*:

- **Anticonvulsants**
 - Carbamazepine
 - Oxcarbazepine
 - Phenobarbital
 - Phenytoin
- **Antimycobacterials**
 - Rifabutin
 - Rifampin
 - Rifapentine
- **Herbal Supplements**
 - St. John's wort
- **HIV Protease Inhibitors**
 - Tipranavir/ritonavir

*Not recommended because of potential marked decrease in sofosbuvir levels

Sofosbuvir: Summary of Key Studies

- **Treatment Naïve (Phase 3)**
 - **NEUTRINO**: GT 1,4,5,6 / SOF + PEG + RBV x 12 weeks
 - **FISSION**: GT 2,3 / SOF + RBV x 12 weeks vs. PEG + RBV x 24 weeks
- **Treatment Naïve (Phase 2)**
 - **ATOMIC**: GT 1,4,5,6 / SOF + PEG + RBV x 12 or 24 weeks
 - **NIH Spare**: GT-1 / SOF + RBV x 24 weeks
 - **PROTON**: GT 1-3 / SOF x 12 weeks + PEG + RBV x 12, 24, or 48 weeks
 - **QUANTUM**: GT 1-4 / SOF, RBV, and GS-0938 x 12 or 24 weeks
- **Treatment Experienced (Phase 3)**
 - **FUSION**: GT 2,3 / SOF + RBV for 12 or 16 weeks
- **Treatment Experienced (Phase 2)**
 - **LONESTAR-2**: GT 2,3 / SOF + PEG + RBV x 12 weeks

Sofosbuvir: Summary of Key Studies

- **Treatment Naïve or Treatment Experienced (Phase 3)**
 - **VALENCE**: GT 2,3 / SOF + RBV for 12 or 16 weeks
 - **POSITRON**: GT 2 or 3 / SOF + RBV x 12 weeks
- **Treatment Naïve or Treatment Experienced (Phase 2)**
 - **ELECTRON**: GT 1-3 / SOF + RBV +/- PEG x 8-12 weeks
 - **Egyptian Ancestry**: GT 4 / SOF + RBV x 8 or 12 weeks
- **Retreatment of Prior Sofosbuvir Failure (Phase 2)**
 - **Retreat**: GT 2,3 / SOF + RBV x 24 weeks vs. SOF, RBV, PEG x 12 weeks
- **HIV Coinfection: Treatment Naïve/Experienced (Phase 3)**
 - **PHOTON-1**: GT 1-3 / SOF + RBV x 12 or 24 weeks
 - **PHOTON-2**: GT 1-4 / SOF + RBV x 12 or 24 weeks
- **HIV Coinfection: Treatment Naïve (Phase 2)**
 - GT 1-4 / SOF + PEG + RBV x 12 weeks

Sofosbuvir: Summary of Key Studies

- **Renal Disease**
 - **HCV Target:** GT 1-6 / Sofosbuvir-containing regimens
- **Liver Transplantation (Phase 2)**
 - **Pre-Liver Transplantation:** Any GT / SOF + RBV x 12-48 weeks
 - **Post-Liver Transplantation:** Any GT / SOF + RBV x 24 weeks
- **Sofosbuvir plus Simeprevir (Phase 2 and 3)**
 - **COSMOS:** GT 1 / SOF + Simeprevir +/- RBV x 12 or 24 weeks
 - **OPTIMIST-1:** Simeprevir + Sofosbuvir in GT1 without cirrhosis
 - **OPTIMIST-2:** Simeprevir + Sofosbuvir in GT1 with cirrhosis
- **Sofosbuvir plus Daclatasvir (Phase 2)**
 - **A1444-040:** GT 1-3; Combinations with Sofosbuvir + Daclatasvir + RBV

Sofosbuvir in Treatment-Naïve Patients

Treatment Naïve

Sofosbuvir + PEG + RBV in Treatment-Naïve HCV GT 1,4,5,6 NEUTRINO Trial*

*Note: Published in NEJM in tandem with **FISSION** Trial (Genotypes 2,3)

Lawitz E, et al. N Engl J Med. 2013;368:1878-87.

Sofosbuvir + PEG + RBV: Treatment-Naive HCV GT 1,4,5,6 NEUTRINO Trial: Features

NEUTRINO Trial: Features

- **Design:** Single-arm, open-label, phase 3 trial of triple therapy with sofosbuvir + peginterferon + ribavirin in HCV genotypes 1, 4, 5, or 6
- **Setting:** 56 sites in United States, enrolled June-August 2012
- **Entry Criteria**
 - Treatment-naïve, chronic HCV monoinfection
 - HCV RNA \geq 10,000 IU/ml
 - HCV Genotypes 1, 4, 5, or 6
- **Patient Characteristics**
 - N = 327
 - HCV Genotype: 1 (89%); 4 (9%); 5 or 6 (2%)
 - IL28B Genotype: 71% non-CC
 - Age and Sex: mean age 52 (range 19-70); 64% male
 - Race: 17% black
 - Liver disease: 17% had cirrhosis
- **Primary End-Point:** SVR12

Sofosbuvir + PEG + RBV: Treatment-Naive HCV GT 1,4,5,6 NEUTRINO Trial: Design

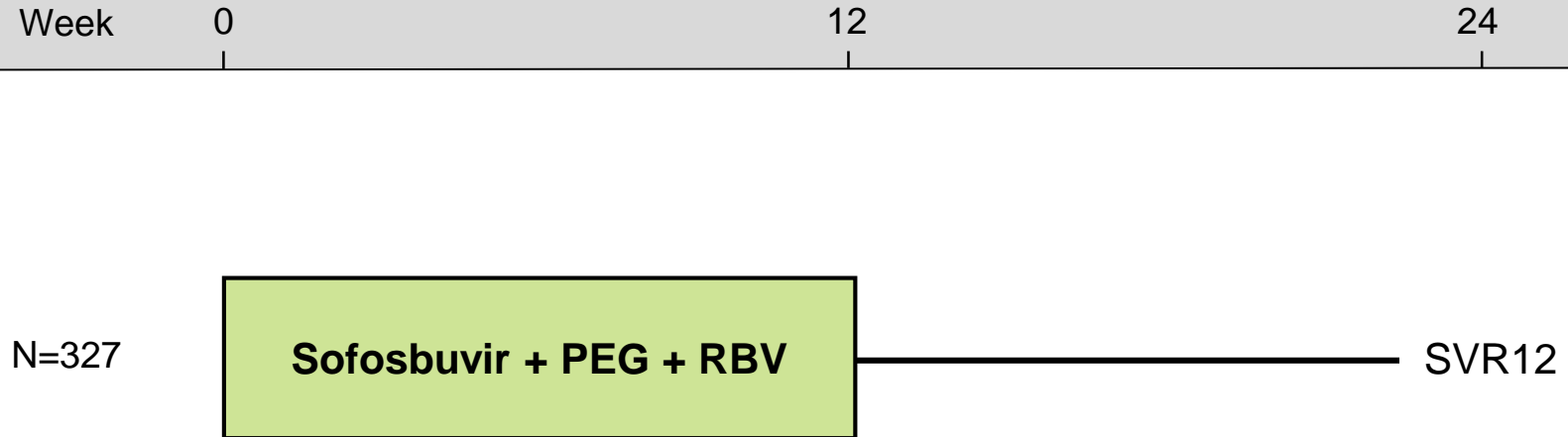

Drug Dosing

Sofosbuvir: 400 mg once daily

Peginterferon alfa-2a: 180 µg once weekly

Ribavirin (weight-based and in 2 divided doses): 1000 mg/day if < 75 kg or 1200 mg/day if ≥ 75 kg

Sofosbuvir + PEG + RBV: Treatment-Naive HCV GT 1,4,5,6 NEUTRINO Trial: Results

NEUTRINO: HCV RNA <25 IU/ml by Study Timepoint

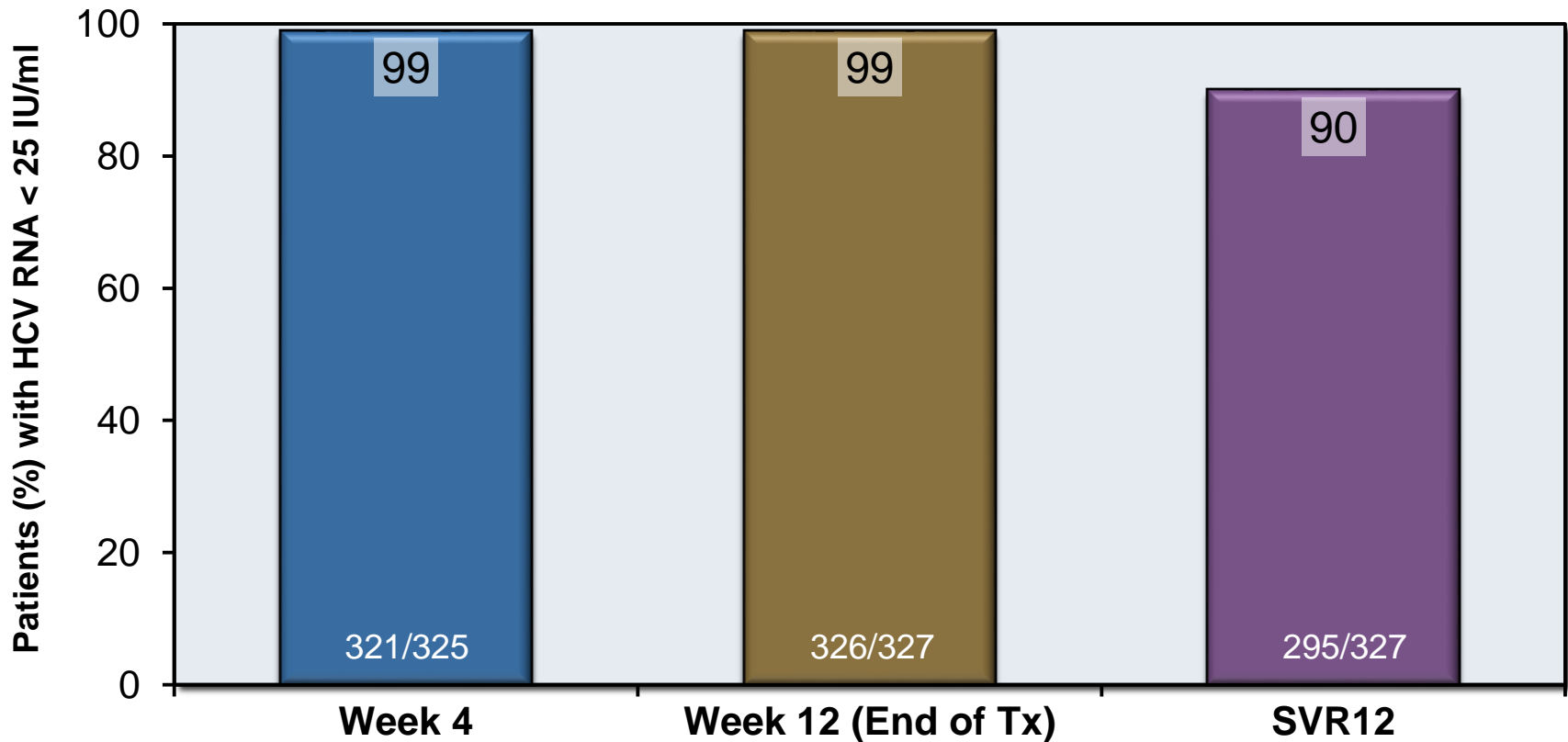

SVR = sustained virologic response

Sofosbuvir + PEG + RBV: Treatment-Naive HCV GT 1,4,5,6 NEUTRINO Trial: Results

NEUTRINO: SVR12 by Genotype

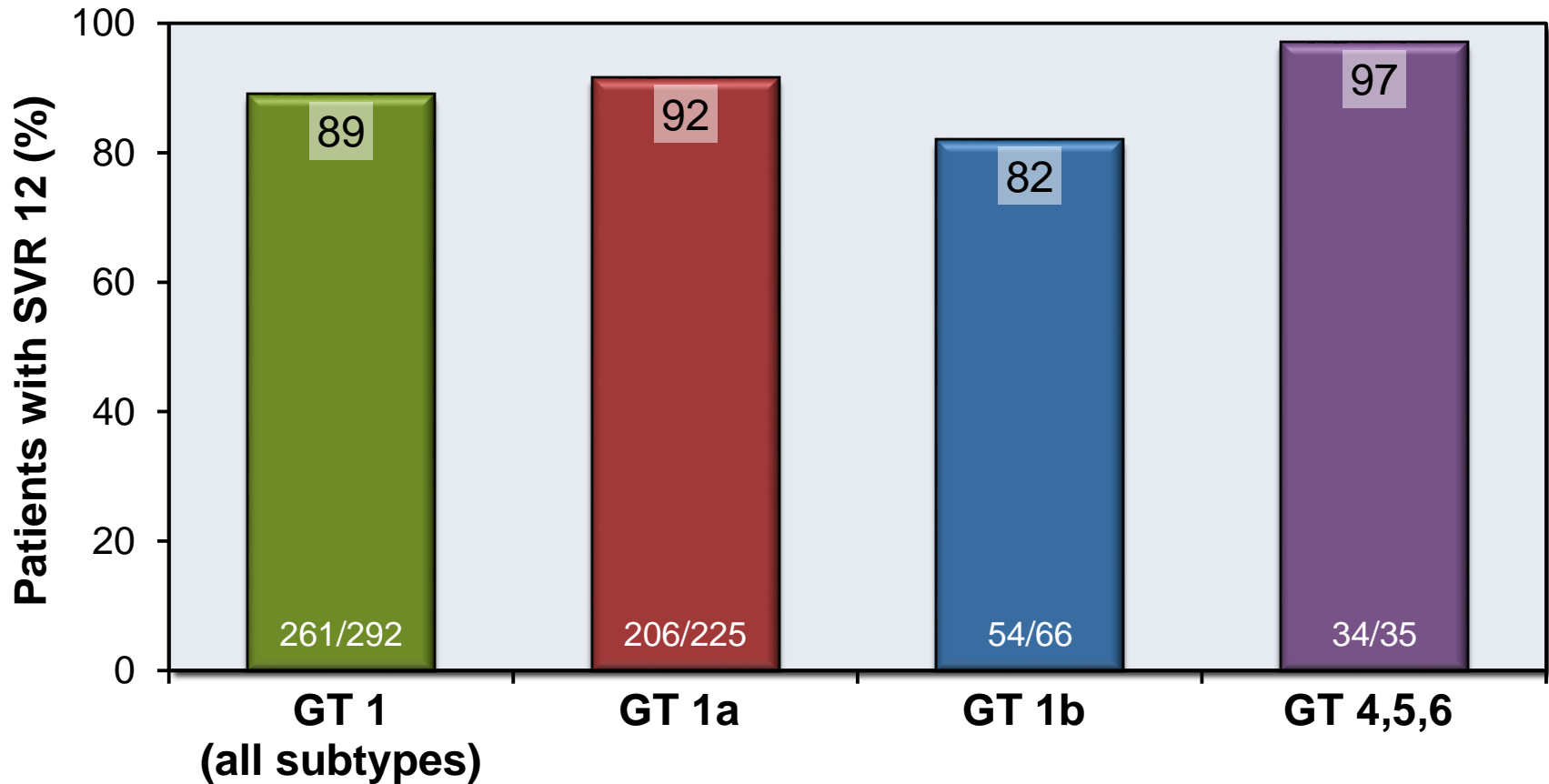

GT = genotype

Source: Lawitz E, et al. N Engl J Med. 2013;368:1878-87.

Sofosbuvir + PEG + RBV: Treatment-Naive HCV GT 1,4,5,6 NEUTRINO Trial: Results

NEUTRINO: SVR12 by Genotype

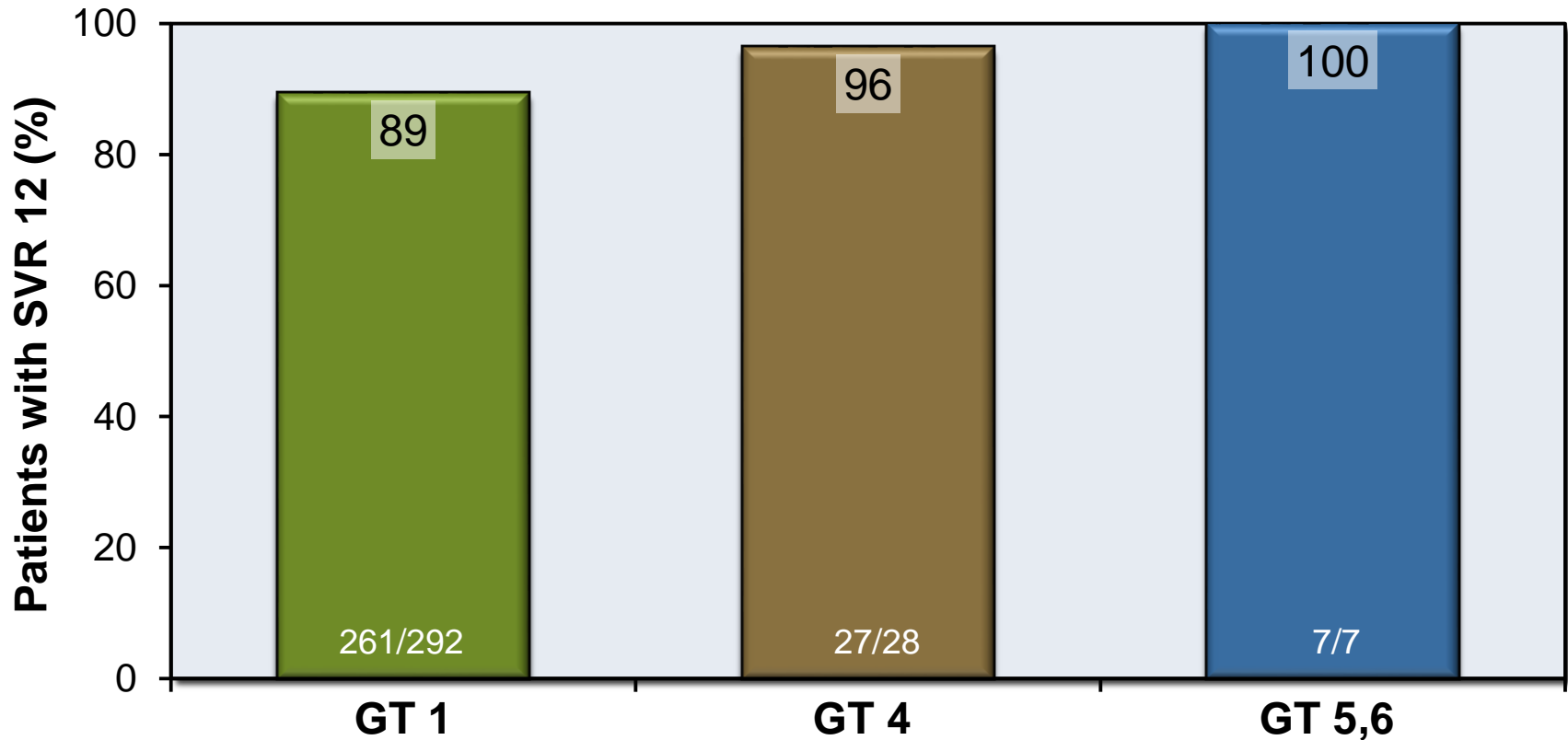

GT = genotype

Source: Lawitz E, et al. N Engl J Med. 2013;368:1878-87.

Sofosbuvir + PEG + RBV: Treatment-Naive HCV GT 1,4,5,6 NEUTRINO Trial: Results

NEUTRINO: SVR12 by Race

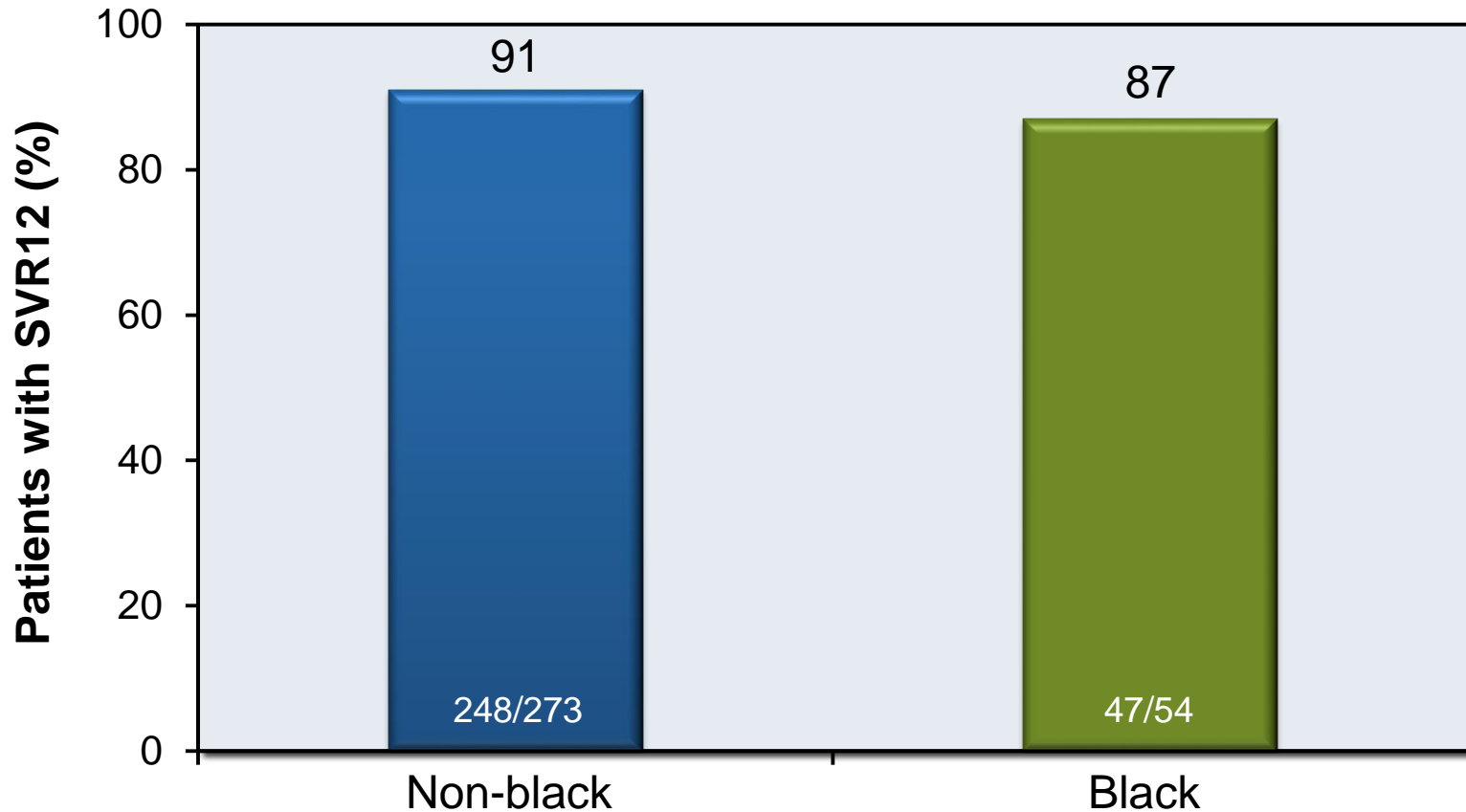

Sofosbuvir + PEG + RBV: Treatment-Naive HCV GT 1,4,5,6 NEUTRINO Trial: Results

NEUTRINO: SVR12 by Liver Disease

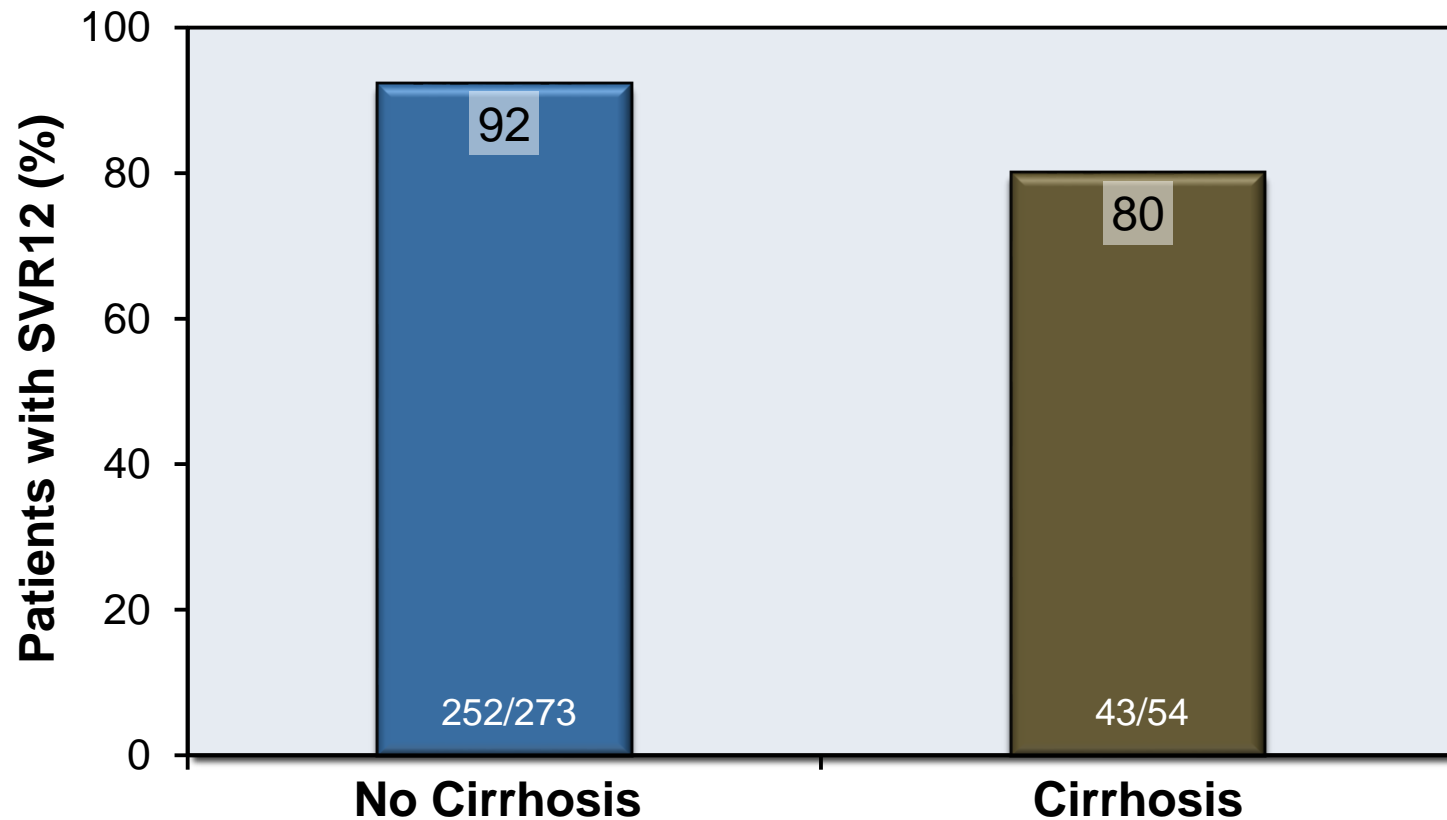

Sofosbuvir + PEG + RBV: Treatment-Naive HCV GT 1,4,5,6 NEUTRINO Trial: Adverse Events

Event	SOF + PEG + RBV (n=327)
Discontinuation due to adverse event	5 (2%)
Fatigue	192 (59%)
Headache	118 (36%)
Nausea	112 (34%)
Rash	59 (18%)
Hemoglobin < 10 g/dl	74 (23%)
Neutropenia	54 (17%)
Influenza-like illness	51 (16%)
Depression	31 (9.5%)
Insomnia	81 (41%)

Rates of adverse events shown in triple therapy did not exceed rates seen in dual therapy (Peg + RBV) arm of FISSION.

Sofosbuvir + PEG + RBV: Treatment-Naive HCV GT 1,4,5,6 NEUTRINO Trial: Conclusions

Conclusions: “In the open-label, single-group study, 12 weeks of treatment with sofosbuvir plus peginterferon-ribavirin had high efficacy in previously untreated patients with genotype 1 or 4 infection, with apparent reductions in adverse effects.”

*Note: This conclusion pertains to both the **NEUTRINO** and **FISSION** trials, which were published in tandem

Treatment Naïve

Sofosbuvir + RBV in Treatment-Naïve Genotypes 2,3 FISSION Trial*

*Note: Published in NEJM in tandem with **NEUTRINO** Trial (Genotypes 1,4,5,6)

Lawitz E, et al. N Engl J Med. 2013;368:1878-87.

Sofosbuvir + Ribavirin for Treatment-Naïve HCV GT 2 or 3

FISSION Trial: Features

FISSION Trial: Features

- **Design:** Randomized, controlled, open-label phase 3 non-inferiority trial comparing sofosbuvir + ribavirin versus PEG + ribavirin in HCV GT 2,3
- **Setting:** 97 sites in US, Australia, New Zealand, Italy, Sweden, and the Netherlands, enrolled Dec 2011-May 2012
- **Entry Criteria**
 - Treatment-naïve, chronic HCV Genotype 2 or 3
 - HCV RNA \geq 10,000 IU/ml
- **Patient Characteristics**
 - N = 499 HCV-monoinfected patients
 - HCV Genotype: 2 (28%); 3 (72%)
 - IL28B Genotype: 57% non-CC
 - Age and Sex: mean age 48 (range 19-77); 66% male
 - Race: 87% white; 3.4% black
 - Liver disease: 20% had cirrhosis
- **Primary End-Point:** SVR12

Sofosbuvir + Ribavirin for Treatment-Naïve HCV GT 2 or 3

FISSION Trial: Design

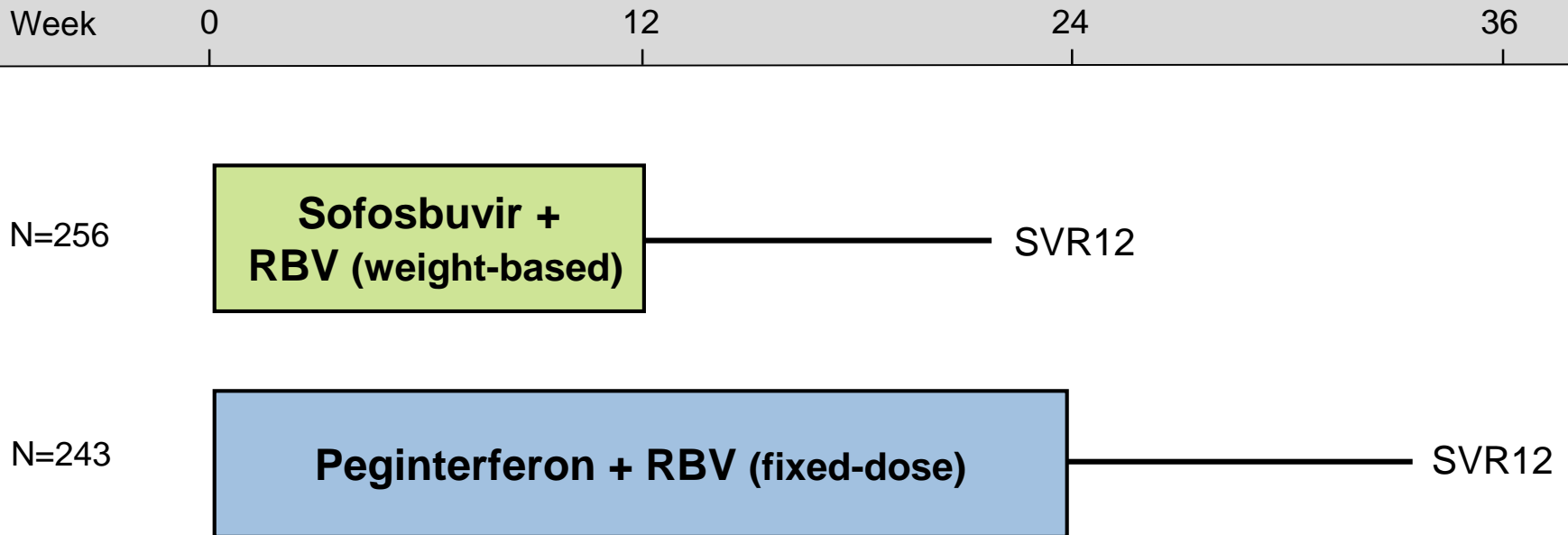

Drug Dosing

Sofosbuvir: 400 mg once daily

Peginterferon alfa-2a: 180 µg once weekly

Weight-based Ribavirin (in 2 divided doses): 1000 mg/day if < 75 kg or 1200 mg/day if ≥ 75 kg

Fixed-dose Ribavirin (in 2 divided doses): 800 mg/day

Sofosbuvir + Ribavirin for Treatment-Naïve HCV GT 2 or 3 FISSION Trial: Results

FISSION: HCV RNA <25 IU/ml by Study Timepoint (GT 2, 3 Combined)

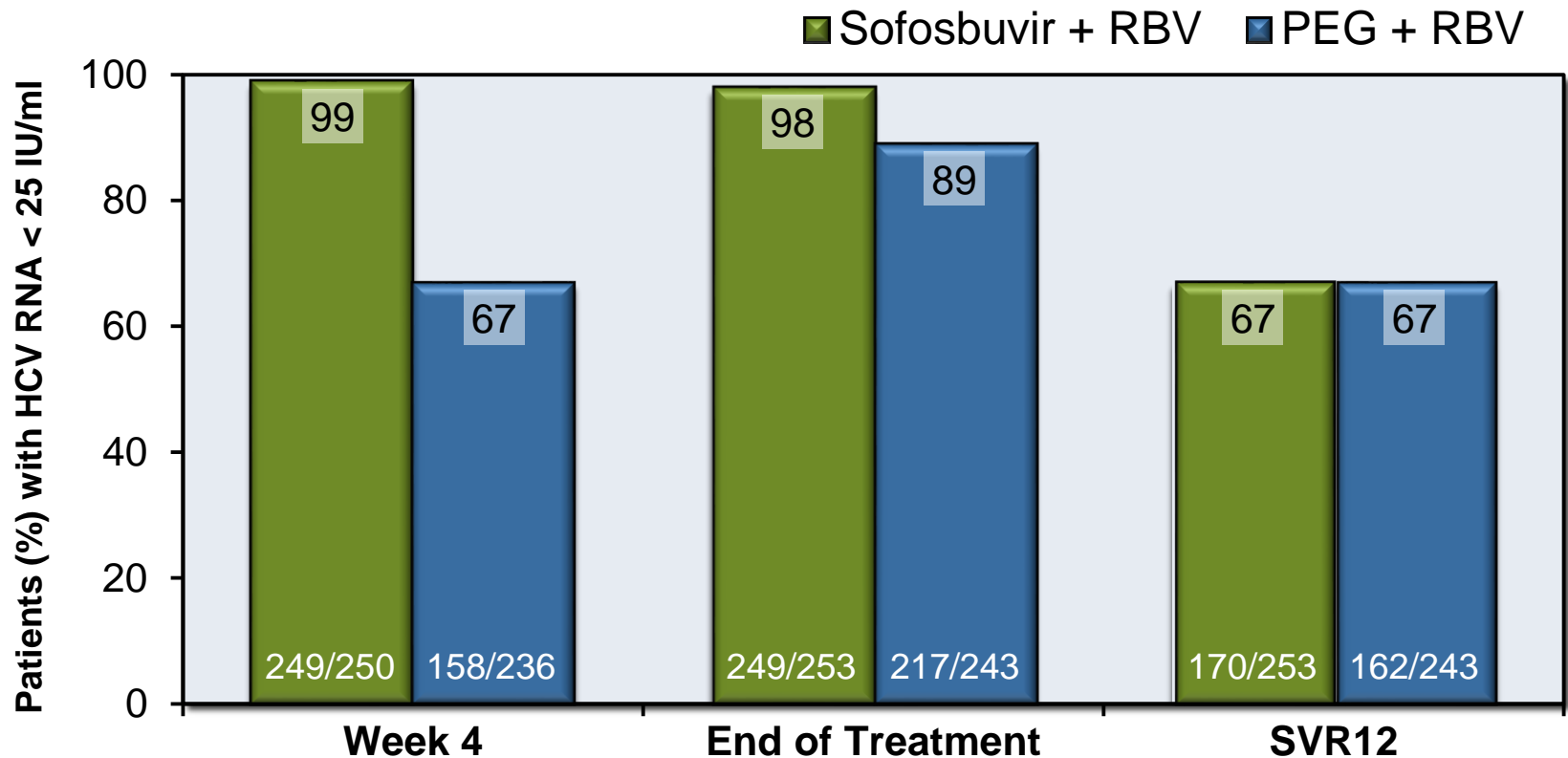

RBV = Ribavirin; PEG = Peginterferon

Source: Lawitz E, et al. N Engl J Med. 2013;368:1878-87.

Sofosbuvir + Ribavirin for Treatment-Naïve HCV GT 2 or 3

FISSION Trial: Results

FISSION: SVR12 by Genotype

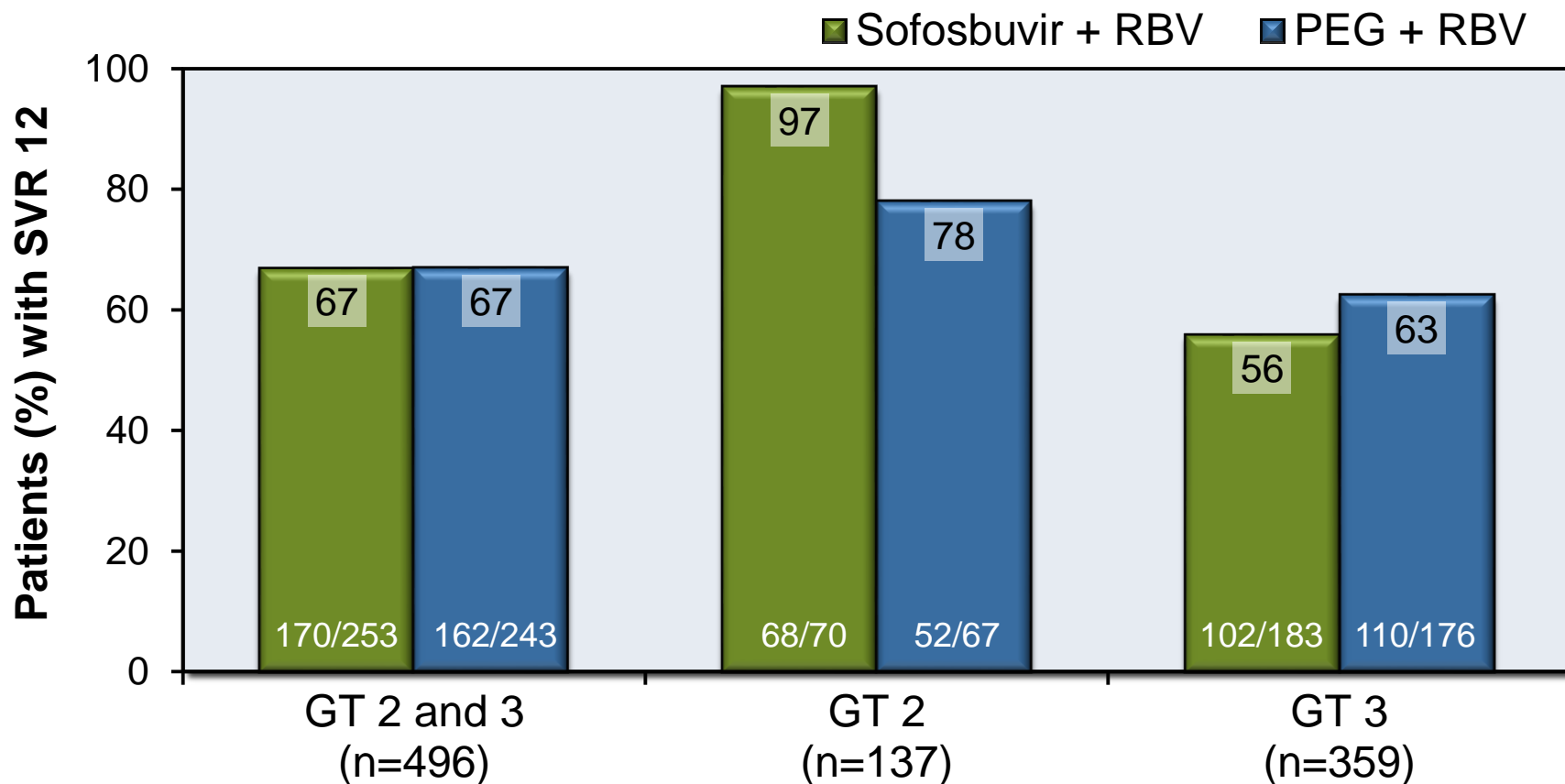

RBV = Ribavirin; PEG = Peginterferon

Source: Lawitz E, et al. N Engl J Med. 2013;368:1878-87.

Sofosbuvir + Ribavirin for Treatment-Naïve HCV GT 2 or 3 FISSION Trial: Results

FISSION: SVR12 by Presence of Cirrhosis

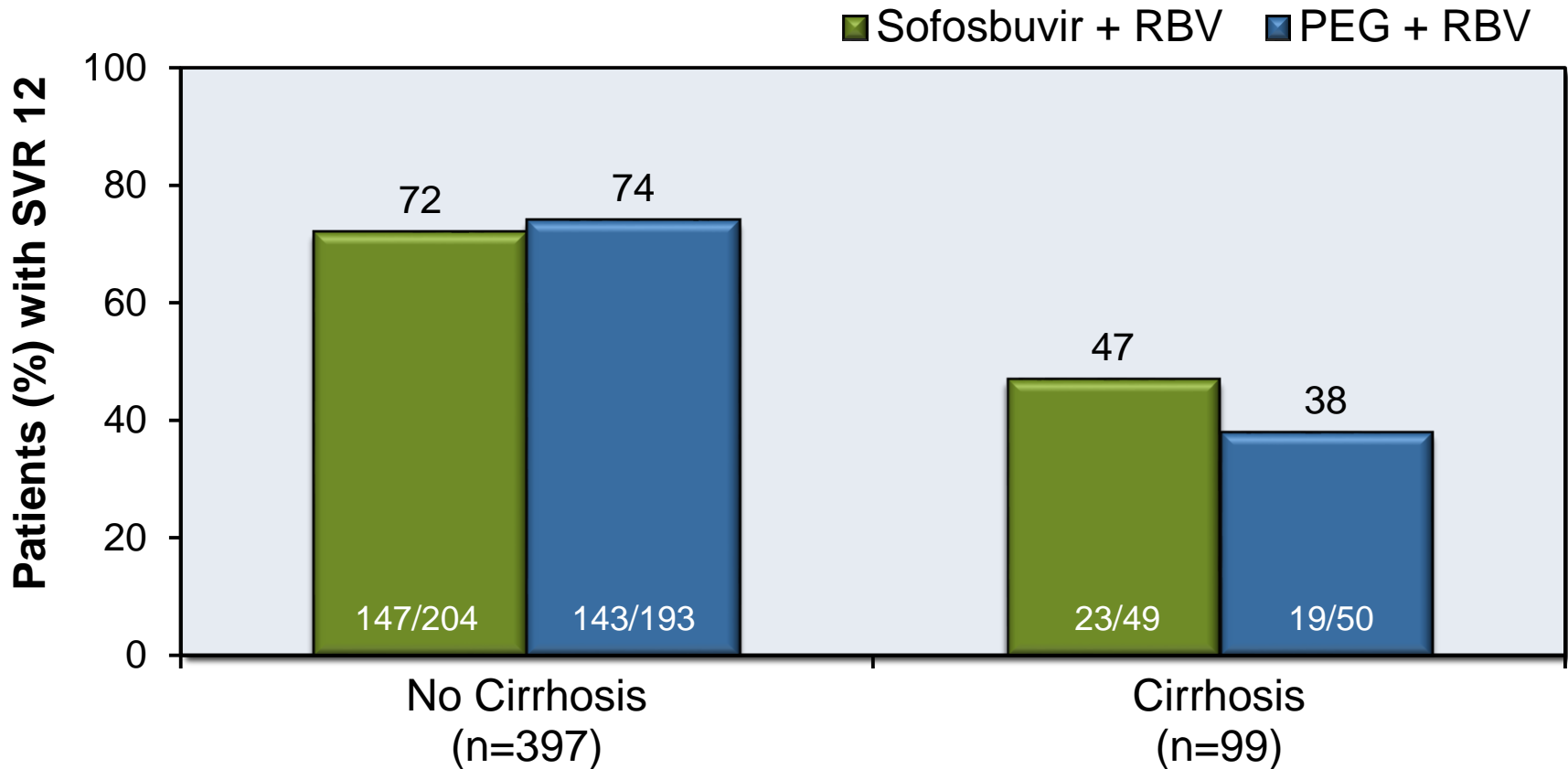

RBV = Ribavirin; PEG = Peginterferon

Sofosbuvir + Ribavirin for Treatment-Naïve HCV GT 2 or 3 FISSION Trial: Adverse Effects

Event	Sofosbuvir + RBV (n=256)	PEG + RBV (n=243)
Discontinuation due to adverse event	3 (1%)	26 (11%)
Fatigue	92 (36%)	134 (55%)
Headache	64 (25%)	108 (44%)
Nausea	46 (18%)	70 (29%)
Pruritus	19 (7%)	42 (17%)
Hemoglobin < 10 g/dl	23 (9%)	35 (14%)
Neutropenia	0	30 (12%)
Influenza-like illness	7 (3%)	43 (18%)
Depression	14 (5.5%)	34 (14%)
Insomnia	31 (12%)	70 (29%)

Sofosbuvir + Ribavirin for Treatment-Naïve HCV GT 2 or 3 FISSION Trial: Conclusions

Conclusions: “In the randomized trial of previously untreated patients with genotype 2 or 3 infection, the efficacy of the all-oral regimen of sofosbuvir plus ribavirin was similar to that of peginterferon–ribavirin, but response rates among patients with genotype 3 infection were lower than the rates among those with genotype 2 infection.”

*Note: This conclusion pertains to both the **FISSION** and **NEUTRINO** trials, which were published in tandem

Treatment Naïve

Sofosbuvir + Peginterferon + Ribavirin in Genotypes 1,4,5,6 ATOMIC

Kowdley K, et al. Lancet. 2013;381:2100-7.

Sofosbuvir + Peginterferon + Ribavirin in Genotypes 1,4,5,6 ATOMIC Trial: Study Overview

ATOMIC Trial: Features

- **Design:** Randomized, open-label, phase 2 trial investigating effectiveness and required duration of sofosbuvir, peginterferon, and ribavirin in treatment-naïve patients with GT 1, 4, 5, or 6
- **Setting:** 42 centers in United States and Puerto Rico
- **Entry Criteria**
 - Chronic HCV infection with HCV genotype 1, 4, 5, or 6
 - Treatment-naïve
 - Age 18 or older
 - HCV RNA \geq 50,000 IU/mL
 - Absence of cirrhosis
 - Absence of coinfection with HBV or HIV
 - BMI \leq 18 kg/m²
- **Primary End-Point:** SVR24

Sofosbuvir + Peginterferon + Ribavirin in Genotypes 1,4,5,6 ATOMIC Trial: Design

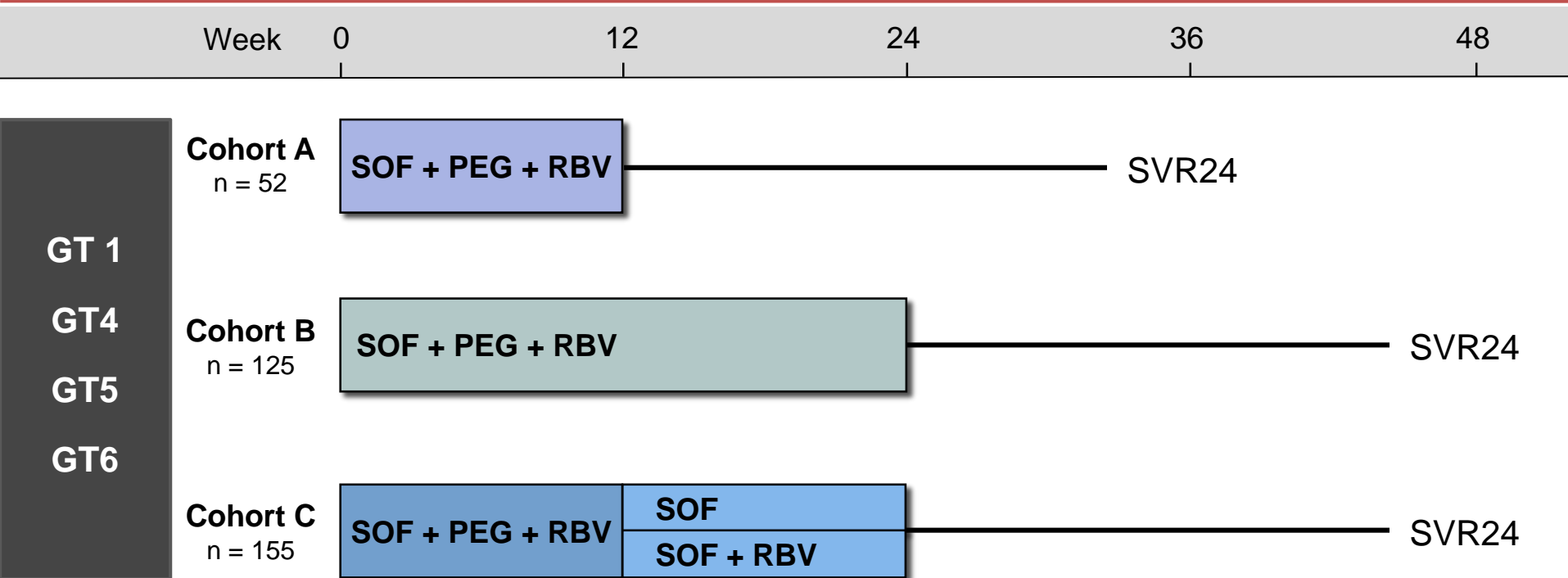

Drug Dosing

Sofosbuvir (SOF): 400 mg once daily

Ribavirin (RBV) weight-based and divided bid: 1000 mg/day if < 75 kg or 1200 mg/day if ≥ 75 kg

Peginterferon alfa-2a (PEG): 180 µg once weekly

Sofosbuvir + Peginterferon + Ribavirin in Genotypes 1,4,5,6 ATOMIC Trial: Results, by Cohort (Regimen)

ATOMIC: SVR24 by Cohort (Regimen)

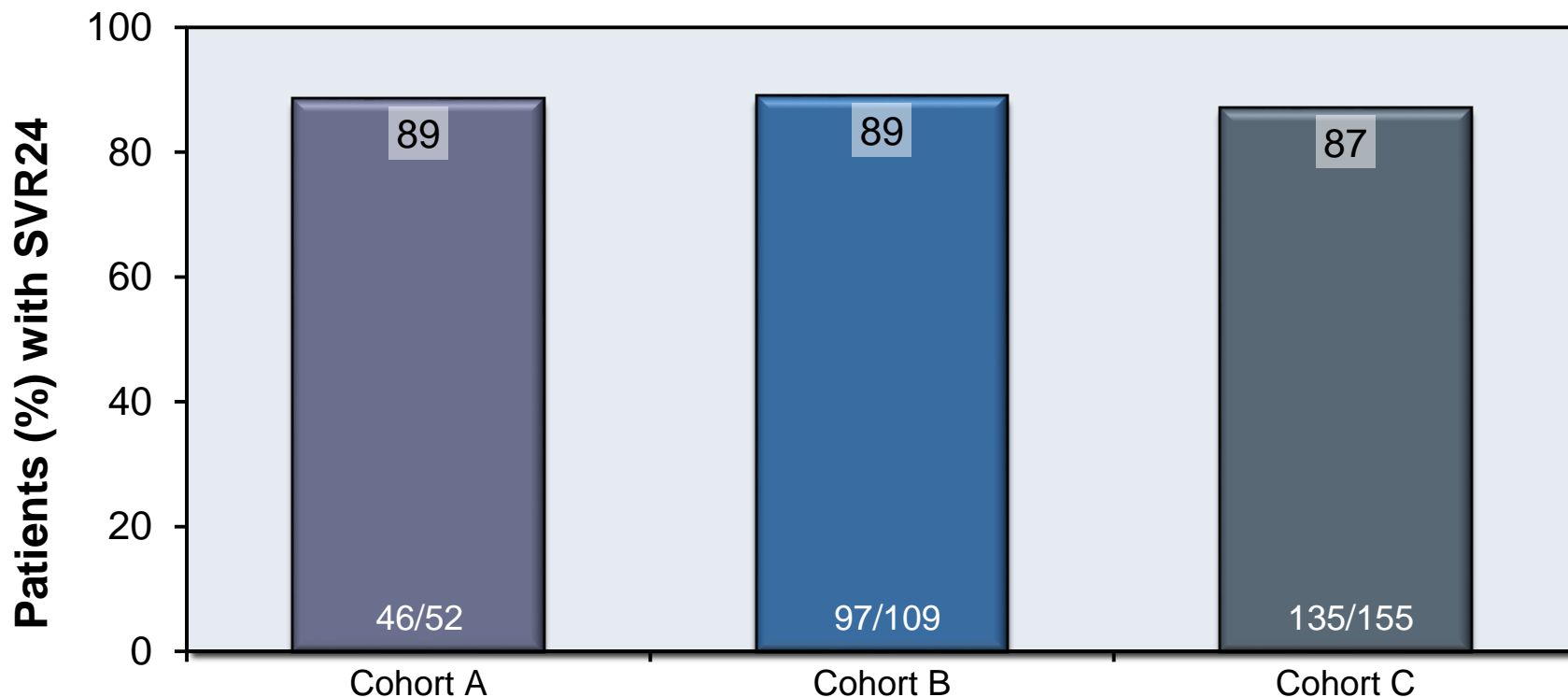

Patients with Genotype 1, 4, or 6

Sofosbuvir + Peginterferon + Ribavirin in Genotypes 1,4,5,6 ATOMIC Trial: Results, by Cohort (Regimen)

ATOMIC: SVR24 by Genotype

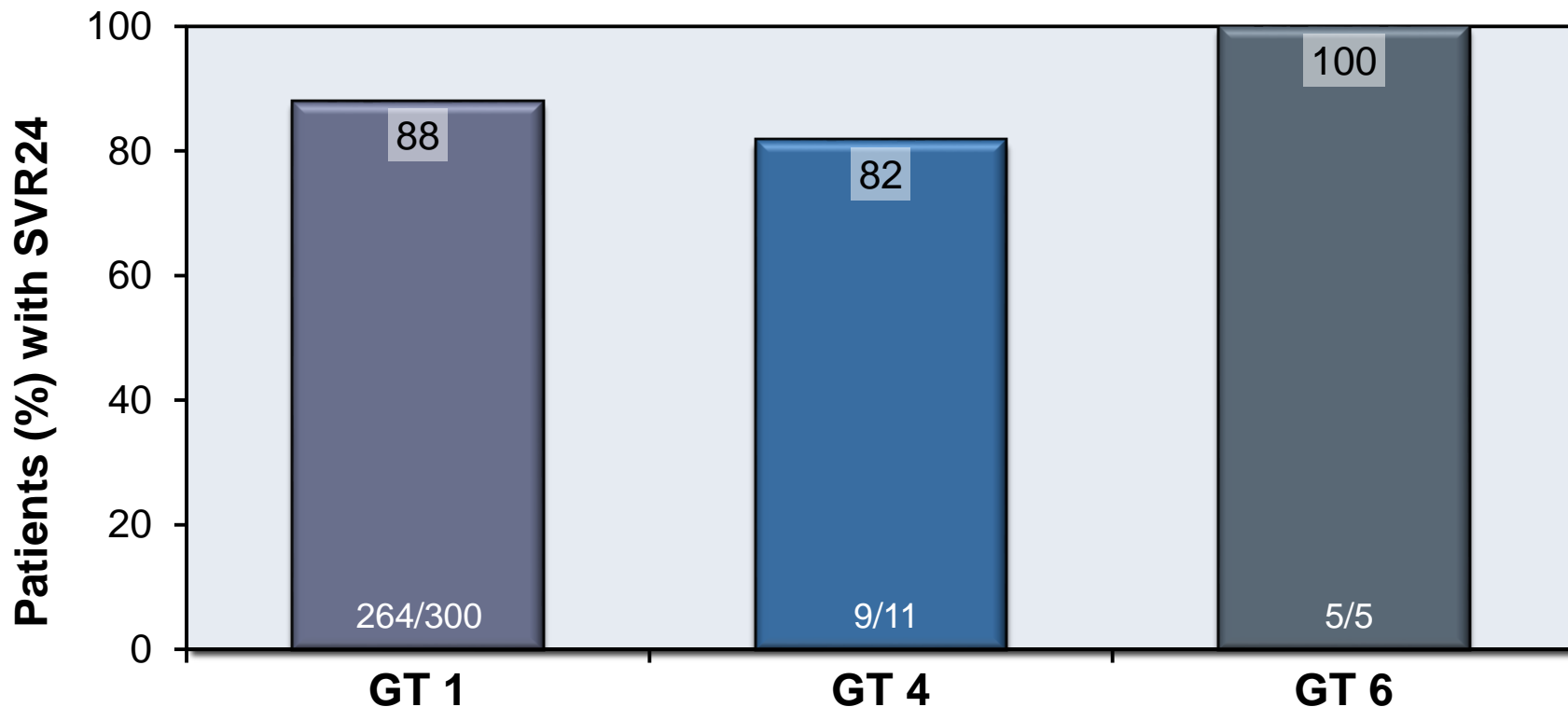

- Notes: (1) No patients with Genotype 5 enrolled in study
(2) All patients with Genotype 4 or 6 received 24 weeks of SOF + PEG + RBV
(3) The 2 patients with Genotype 4 and failure resulted from lost to follow-up at end of treatment

Sofosbuvir + Peginterferon + Ribavirin in Genotypes 1,4,5,6 ATOMIC Trial: Interpretation

Interpretation: “Our findings suggest that sofosbuvir is well tolerated and that there is no additional benefit of extending treatment beyond 12 weeks, but these finding will have to be substantiated in phase 3 trials. These results lend support to the further assessment of a 12 week sofosbuvir regimen in a broader population of patients with chronic HCV genotype-1 infection, including those with cirrhosis.”

Treatment Naïve (unfavorable baseline treatment characteristics)

Sofosbuvir + Ribavirin in HCV Genotype 1 NIAID SPARE

Osinusi A, et al. JAMA. 2013;310:804-11.

Sofosbuvir and Ribavirin for Treatment-Naïve HCV GT 1

NIAID SPARE Trial: Features

NIAID Spare Trial: Features

- **Design**
 - Randomized, open-label, 2-part, phase 2 study of sofosbuvir and ribavirin
 - Part 1: “proof of concept”
 - Part 2: low dose versus weight-based dose of ribavirin in GT-1
- **Setting:** Single center: NIH
- **Entry Criteria:** HCV genotype 1; treatment-naïve
- **Patient Characteristics**
 - N = 60 HCV-monoinfected patients
 - HCV Genotype: 1A (70%), 1B (30%)
 - IL28B Genotype: 81% non-CC
 - Age and Sex: median 54 (range 48-57); 62% male
 - Race: 83% black; 13% white
 - Liver disease: 23% had advanced fibrosis (F3-F4 by Knodell-HAI scoring)
- **Primary end-points:** Efficacy (SVR24) and safety

Sofosbuvir and Ribavirin for Treatment-Naïve HCV GT 1

NIAID SPARE Trial: Design

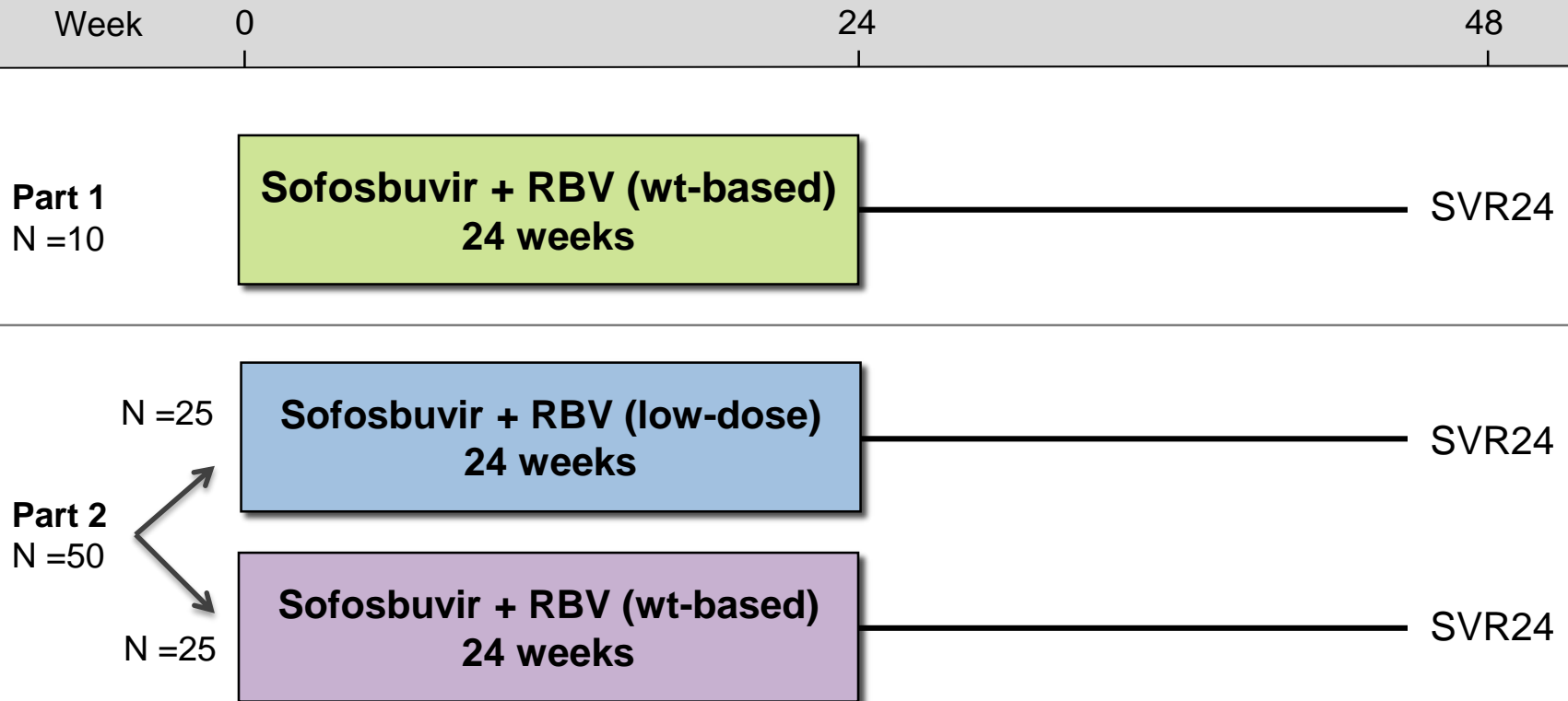

Drug Dosing

Sofosbuvir: 400 mg once daily

Low-dose Ribavirin (divided bid): 800 mg/day

Weight-based Ribavirin (divided bid): 1000 mg/day if < 75 kg or 1200 mg/day if ≥ 75 kg

Sofosbuvir and Ribavirin for Treatment-Naïve HCV GT 1 NIAID SPARE Trial: Part 1 Results

NIAID SPARE Part 1: HCV <12 IU/ml by Study Timepoint

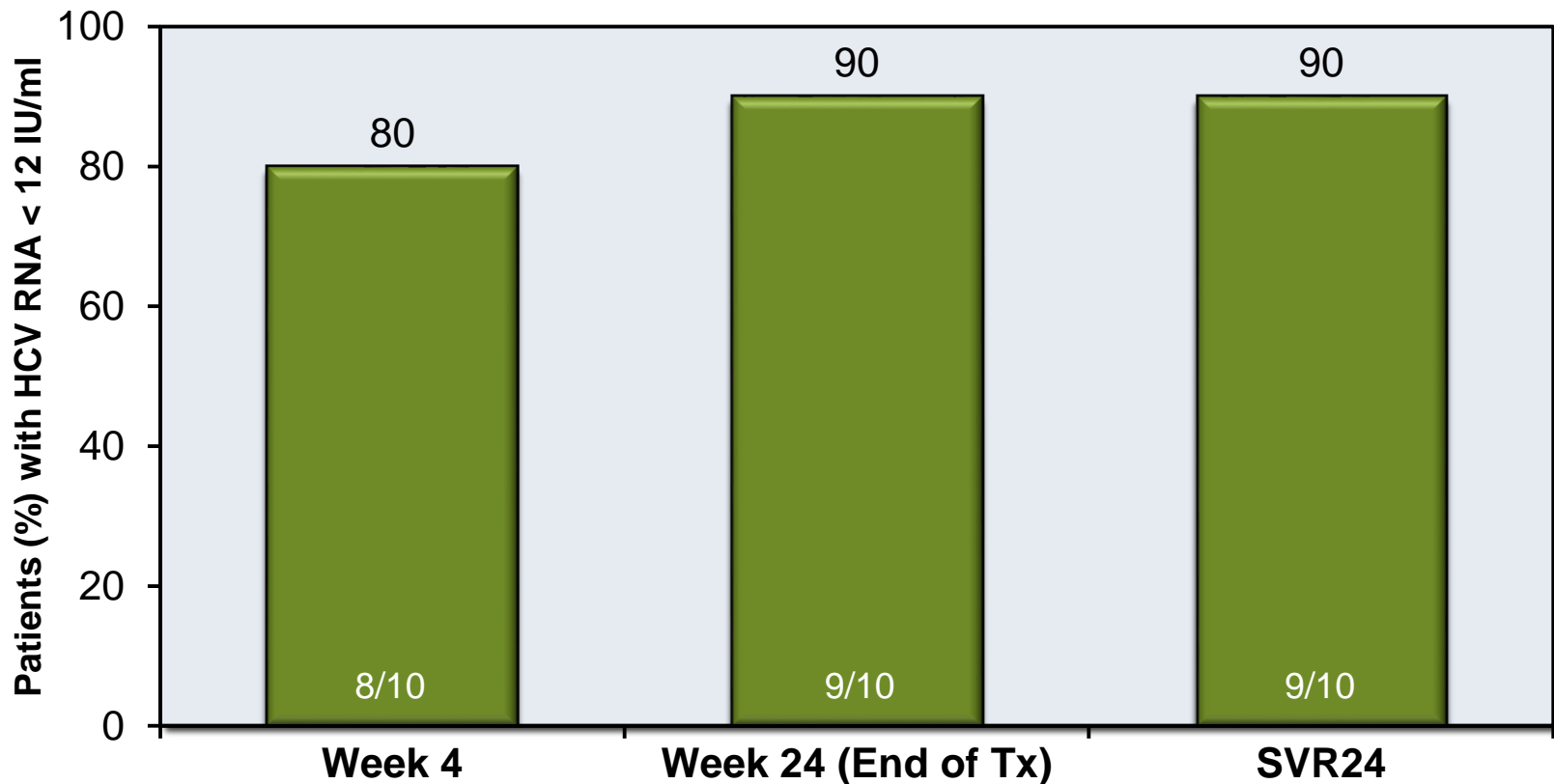

All 10 patients in Part 1 received sofosbuvir plus weight-based ribavirin

Source: Osinusi A, et al. *JAMA*. 2013;310:804-11.

Sofosbuvir and Ribavirin for Treatment-Naïve HCV GT 1 NIAID SPARE Trial: Part 2 Results

NIAID SPARE Part 2: HCV RNA <12 IU/ml by Study Timepoint

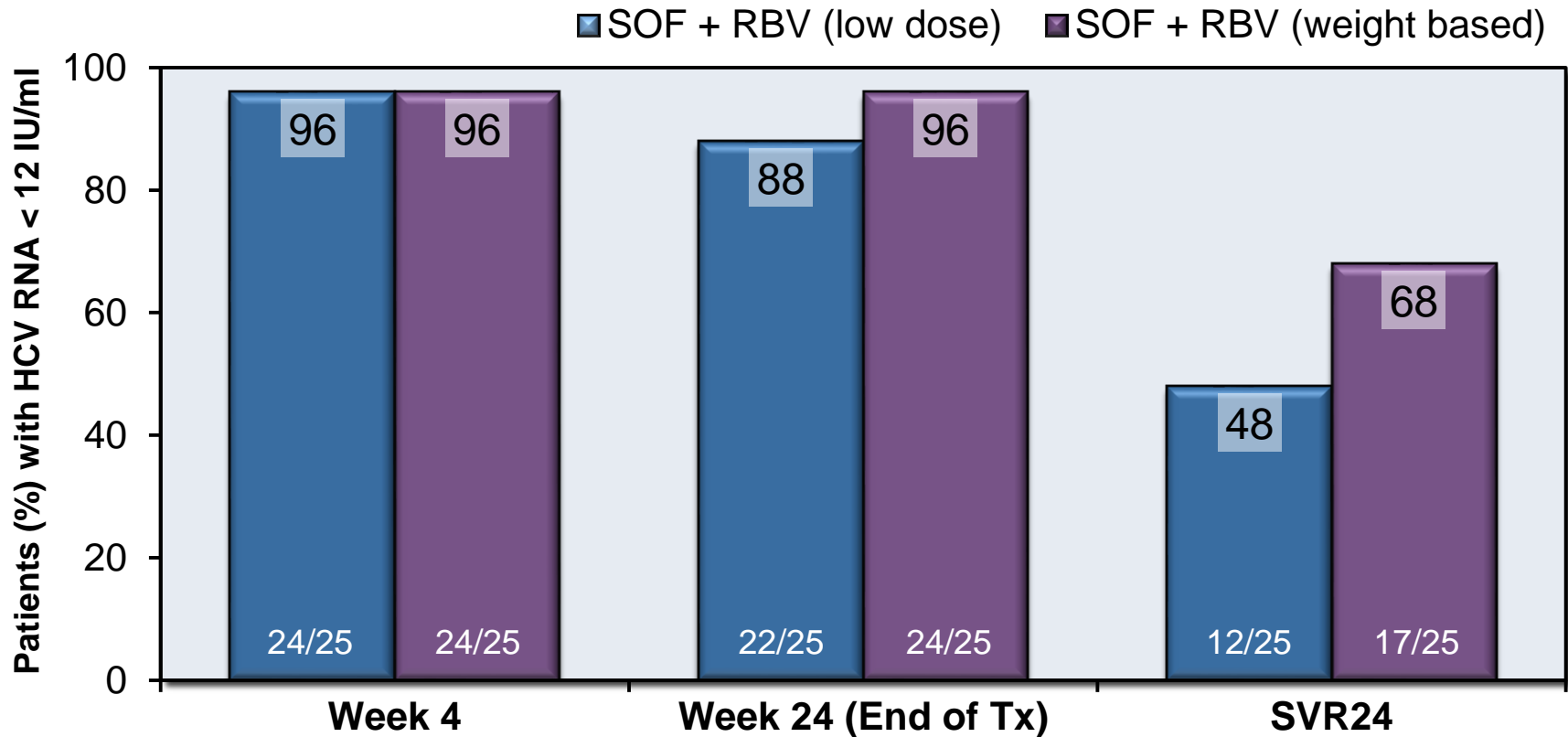

SOF = Sofosbuvir; RBV = Ribavirin

Source: Osinusi A, et al. JAMA. 2013;310:804-11.

Sofosbuvir and Ribavirin for Treatment-Naïve HCV GT 1 NIAID SPARE Trial: Part 2 Results

NIAID SPARE Part 2: SVR24 by Fibrosis Stage

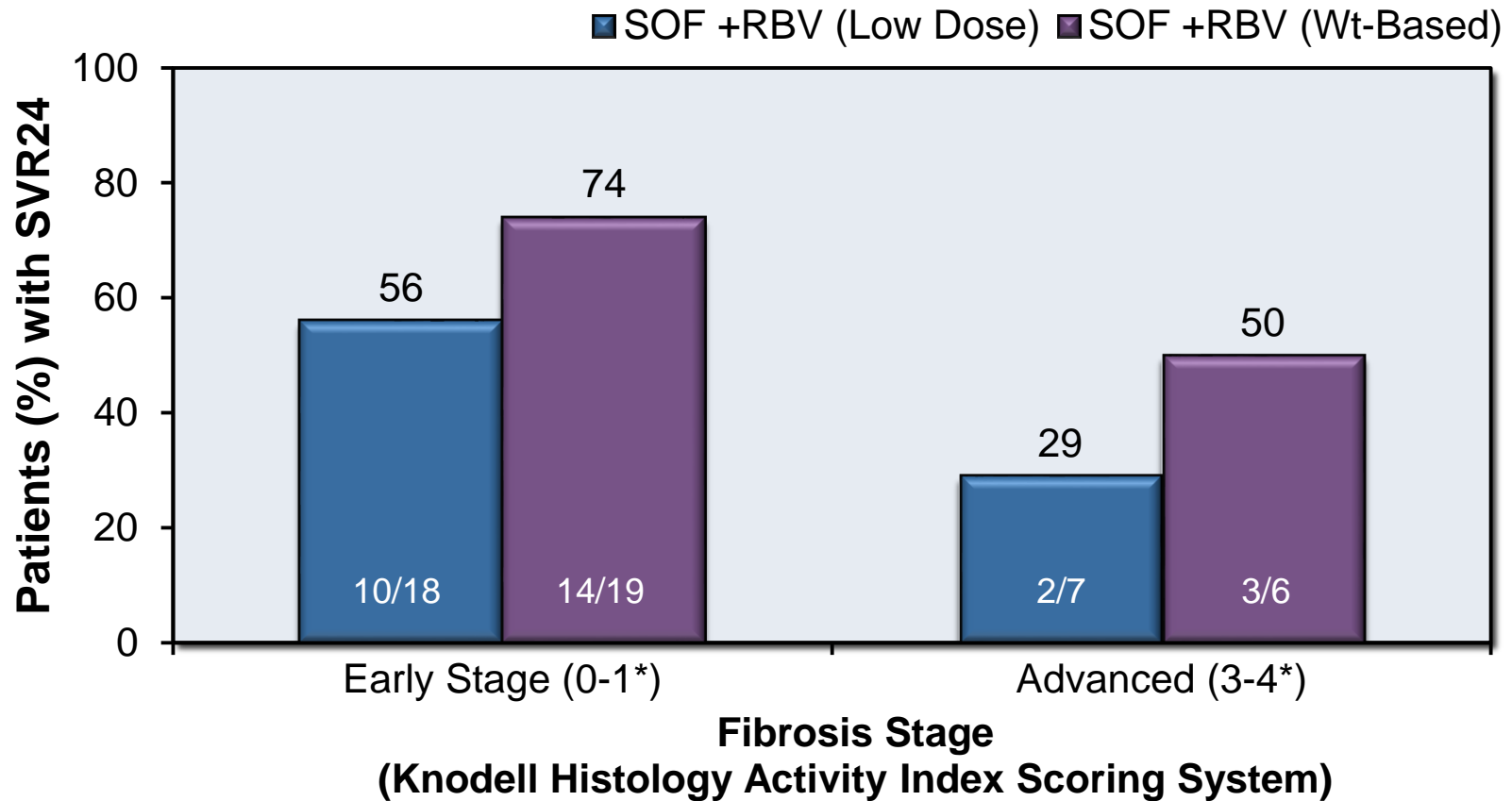

SOF = Sofosbuvir; RBV = Ribavirin

Source: Osinusi A, et al. JAMA. 2013;310:804-11.

Sofosbuvir and Ribavirin for Treatment-Naïve HCV GT 1 NIAID SPARE Trial: Part 2 Results

NIAID SPARE Part 2: SVR24 by Baseline HCV RNA Level

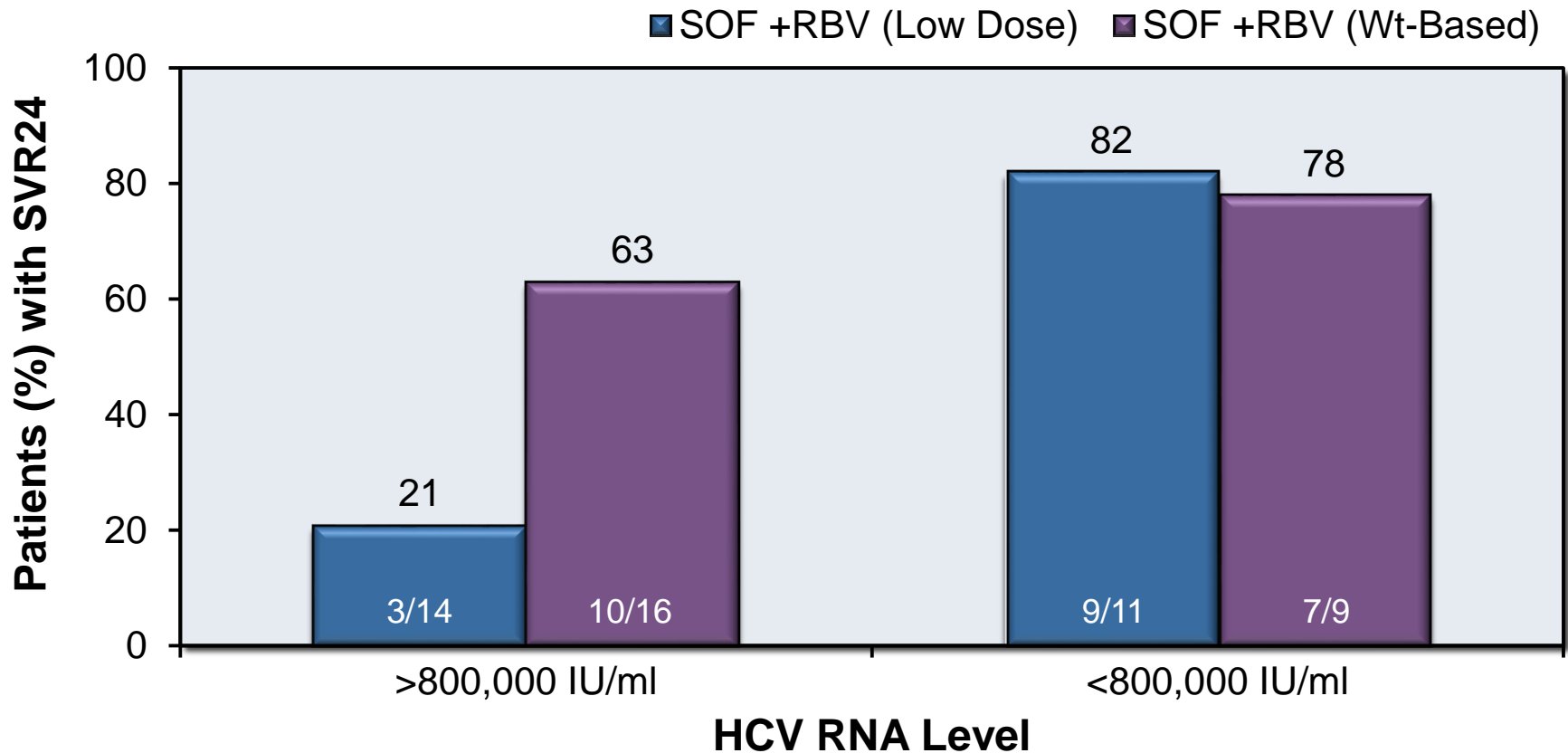

SOF= Sofosbuvir; RBV = Ribavirin

Source: Osinusi A, et al. JAMA. 2013;310:804-11.

Sofosbuvir and Ribavirin for Treatment-Naïve HCV GT 1 NIAID SPARE Trial: Conclusions

Conclusion: “In conclusion, treatment with a 24-week regimen of sofosbuvir and ribavirin resulted in an SVR rate of 68% in the weight-based ribavirin regimen and 48% in the low-dose ribavirin regimen among patients with chronic HCV and unfavorable traditional predictors of treatment response who are representative of the demographics of the US HCV epidemic.”

Treatment Naïve

Sofosbuvir + Ribavirin + Peginterferon in Genotypes 1-3 PROTON

Lawitz E, et al. Lancet Infect Dis. 2013;13:401-8.

Sofosbuvir + Ribavirin + Peginterferon in Genotypes 1-3

PROTON Trial: Design

PROTON Trial: Features

- **Design:** Randomized, two-cohort, phase 2 trial investigating effectiveness of sofosbuvir, ribavirin, and peginterferon in treatment-naïve GT 1-3
- **Setting:** 22 hepatitis C treatment centers in the United States
- **Entry Criteria**
 - Treatment-naïve
 - HCV RNA RNA \geq 50,000 IU/mL
 - Absence of cirrhosis
- **Patient Characteristics**
 - GT-1 = 121; GT 2= 15; GT 3 = 10
- **Study Arms**
 - Cohort A: GT1; three arms and included 2 doses of sofosbuvir
 - Cohort B: GT 2 or 3
- **Primary End-Point:** SVR24

Sofosbuvir + Peginterferon + Ribavirin in Genotypes 1-3 PROTON Trial: Design

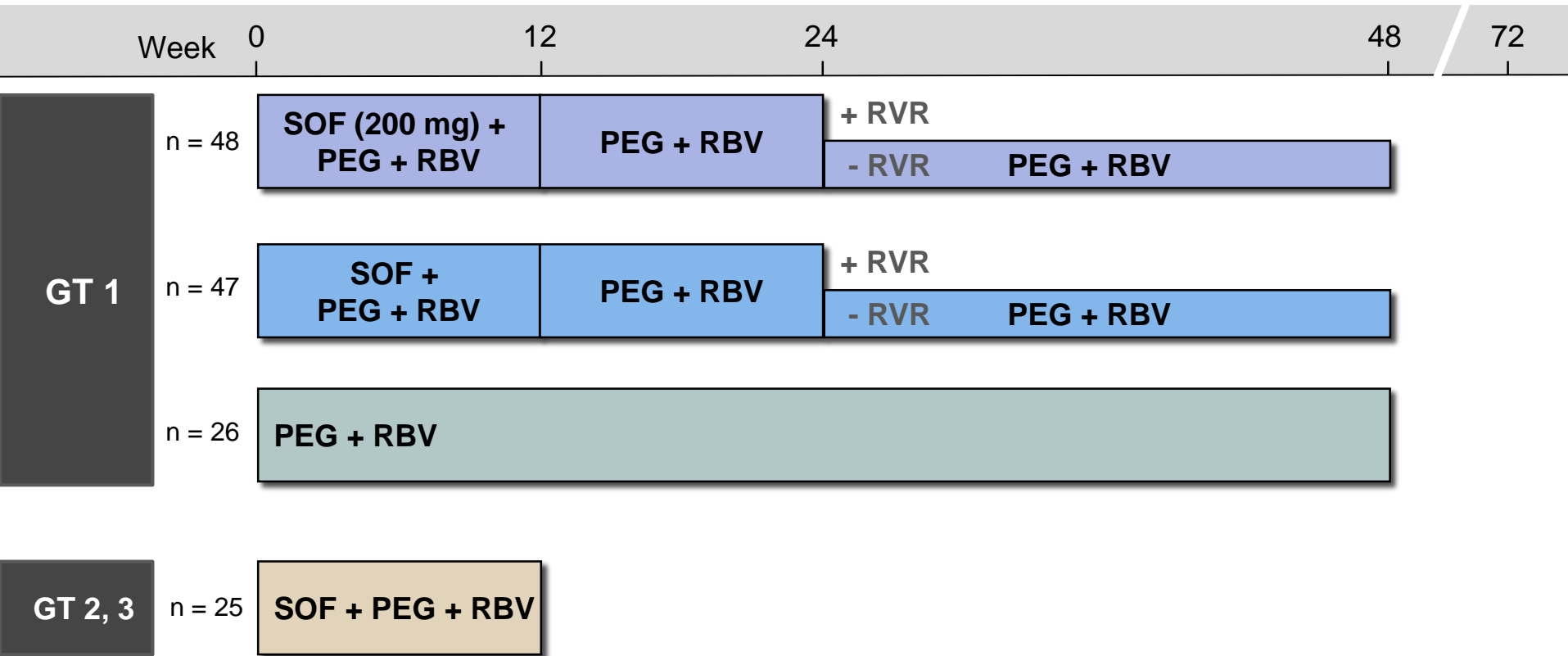

Drug Dosing

Sofosbuvir (SOF): 400 mg once daily, except as designated in arm that received 200 mg once daily

Ribavirin (RBV) weight-based and divided bid: 1000 mg/day if < 75 kg or 1200 mg/day if ≥ 75 kg

Peginterferon alfa-2a (PEG): 180 µg once weekly

Sofosbuvir + Ribavirin + Peginterferon in Genotypes 1-3 PROTON Trial: Results, by Genotype

PROTON: SVR 24

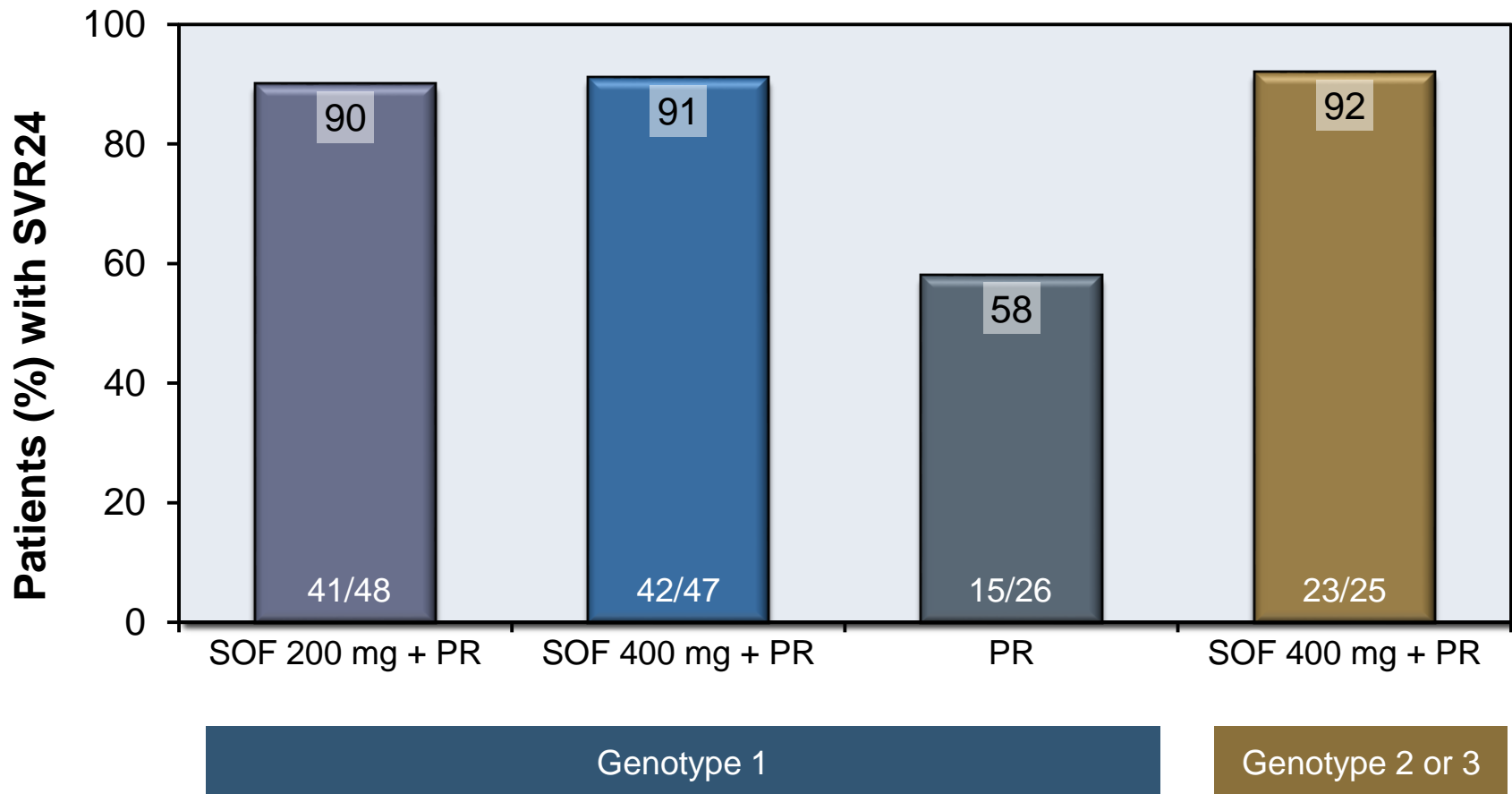

Sofosbuvir + Ribavirin + Peginterferon in Genotypes 1-3 PROTON Trial: Conclusions

Interpretation: “Our findings lend support to the further assessment, in phase 2 and 3 trials, of sofosbuvir 400 mg plus peginterferon and ribavirin for 12 weeks in treatment-naive patients with HCV genotype-1.”

Treatment Naïve

Sofosbuvir, Ribavirin, GS-0938 in GT 1-4 QUANTUM

Lalezari JP, et al. EASL. 2013; Abstract 845.

Sofosbuvir, Ribavirin, & GS-0938 in Treatment Naïve QUANTUM Trial: Features

FUSION Trial: Features

- **Design:** Randomized, double-blind, phase 2b trial comparing combinations of sofosbuvir, ribavirin, and GS-0938 in treatment-naïve GT 1-4
- **Setting:** 44 hepatitis C treatment centers in the United States
- **Entry Criteria**
 - Treatment-naïve
 - HCV RNA RNA \geq 50,000 IU/mL
- **Patient Characteristics**
 - N = 235 HCV-monoinfected patients
 - GT-1 = 73-79%; GT-2 = 8-13%; GT-3 = 11-16%; GT-4 = 0-6%
- **Study Modification**
 - All arms with GS-0938 halted due increases in ALT/AST > 5x baseline
 - Patients (n = 132) on GS-0938 regimen who did not achieve SRV retreated with 24 week course of SOF + RBV
- **Primary End-Point:** SVR12

Sofosbuvir, Ribavirin, & GS-0938 in Treatment Naïve QUANTUM Trial: Design

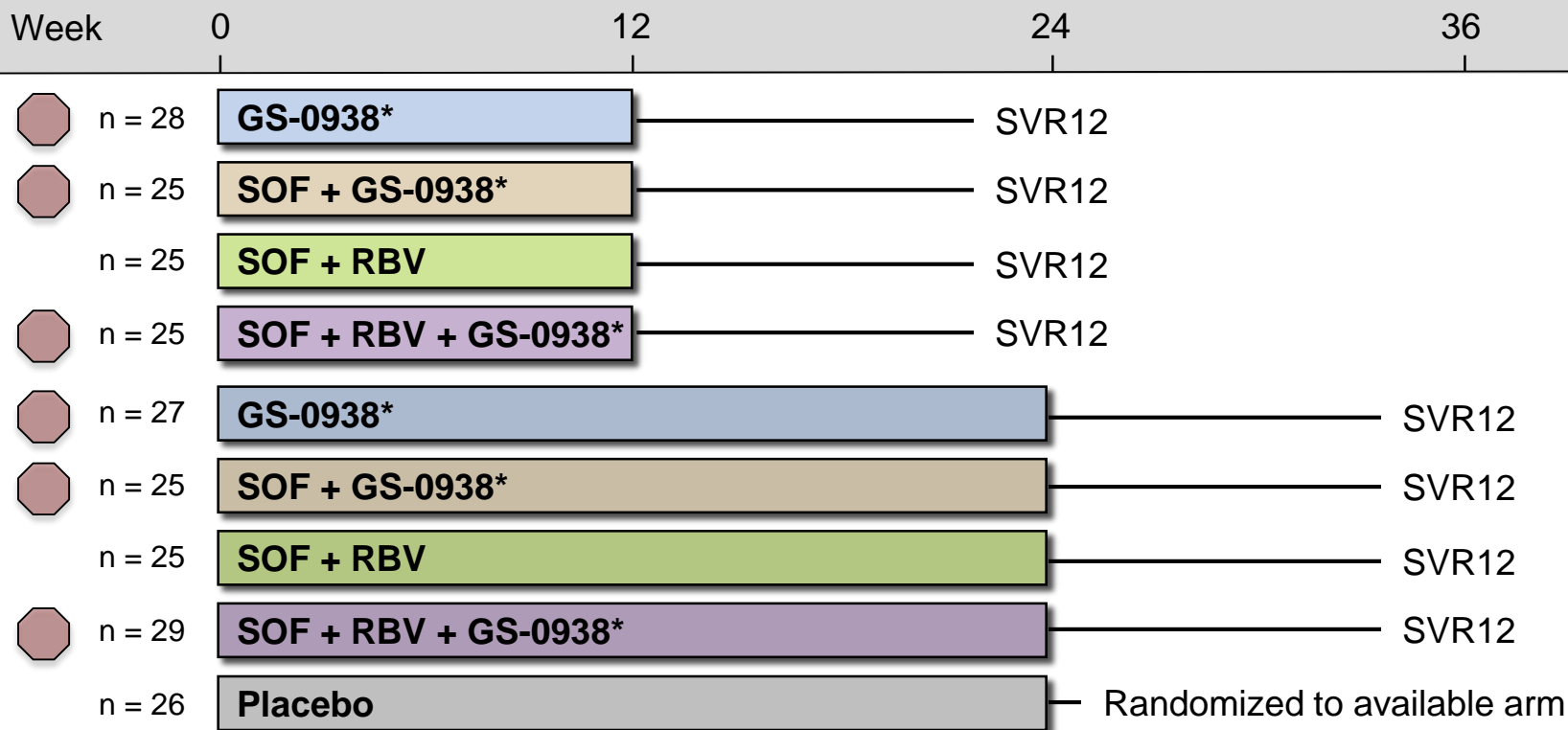

Study Modification: all GS-0938 arms stopped; patients without SVR12 retreated with SOF + RBV x 24 weeks

Drug Dosing

Sofosbuvir (SOF): 400 mg once daily

Ribavirin (RBV) weight-based and divided bid: 1000 mg/day if < 75 kg or 1200 mg/day if ≥ 75 kg

GS-0938: 300 mg once daily

Sofosbuvir, Ribavirin, & GS-0938 in Treatment Naïve QUANTUM Trial: Results

QUANTUM: SVR12 Results for Completed Arms (all genotypes)

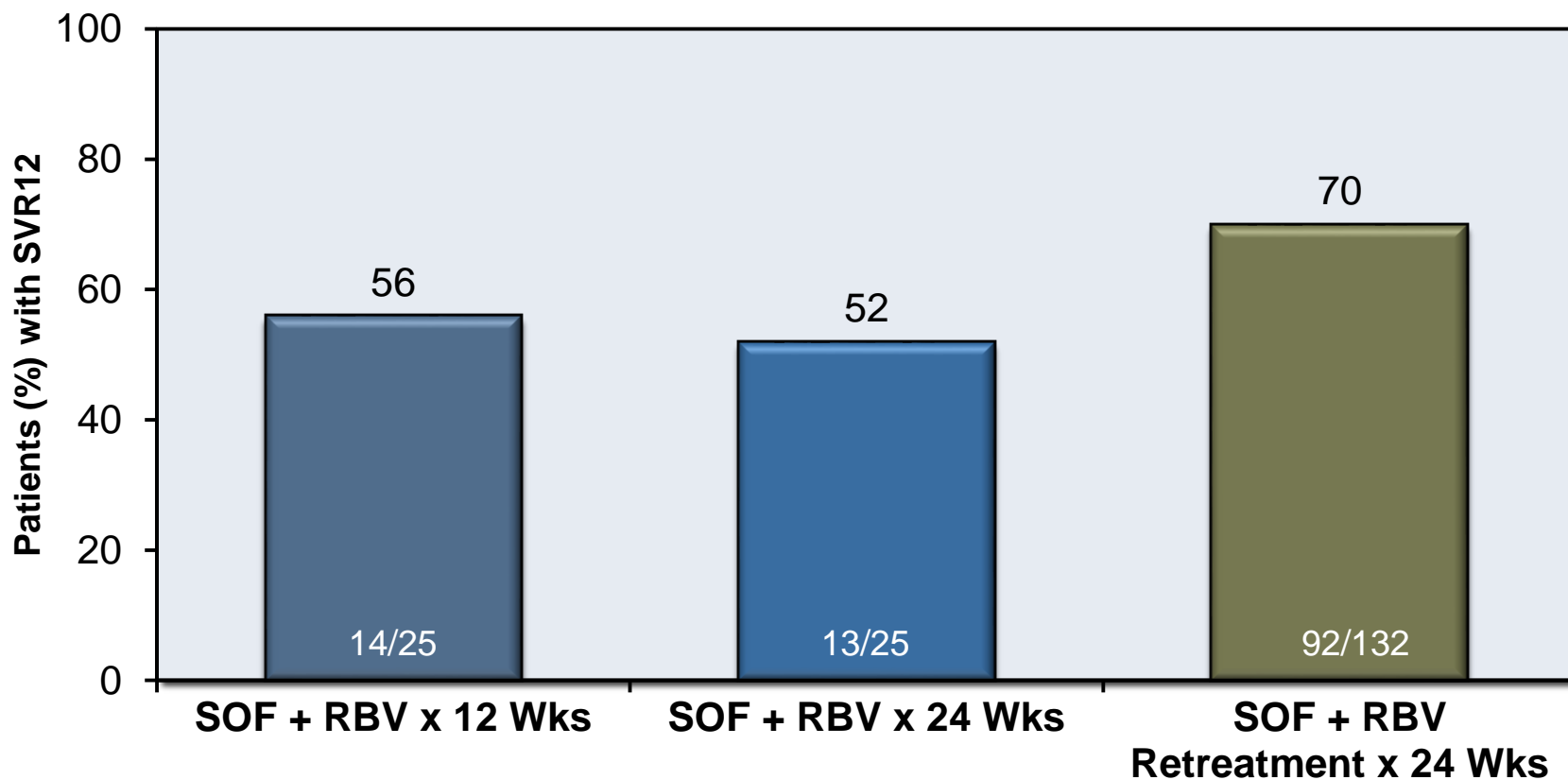

SOF = sofosbuvir; RBV = ribavirin

Source: Lalezari JP, et al. EASL. 2013; Abstract 845.

Sofosbuvir, Ribavirin, & GS-0938 in Treatment Naïve QUANTUM Trial: Results

QUANTUM: SVR12 Results for Patients with Genotype 1

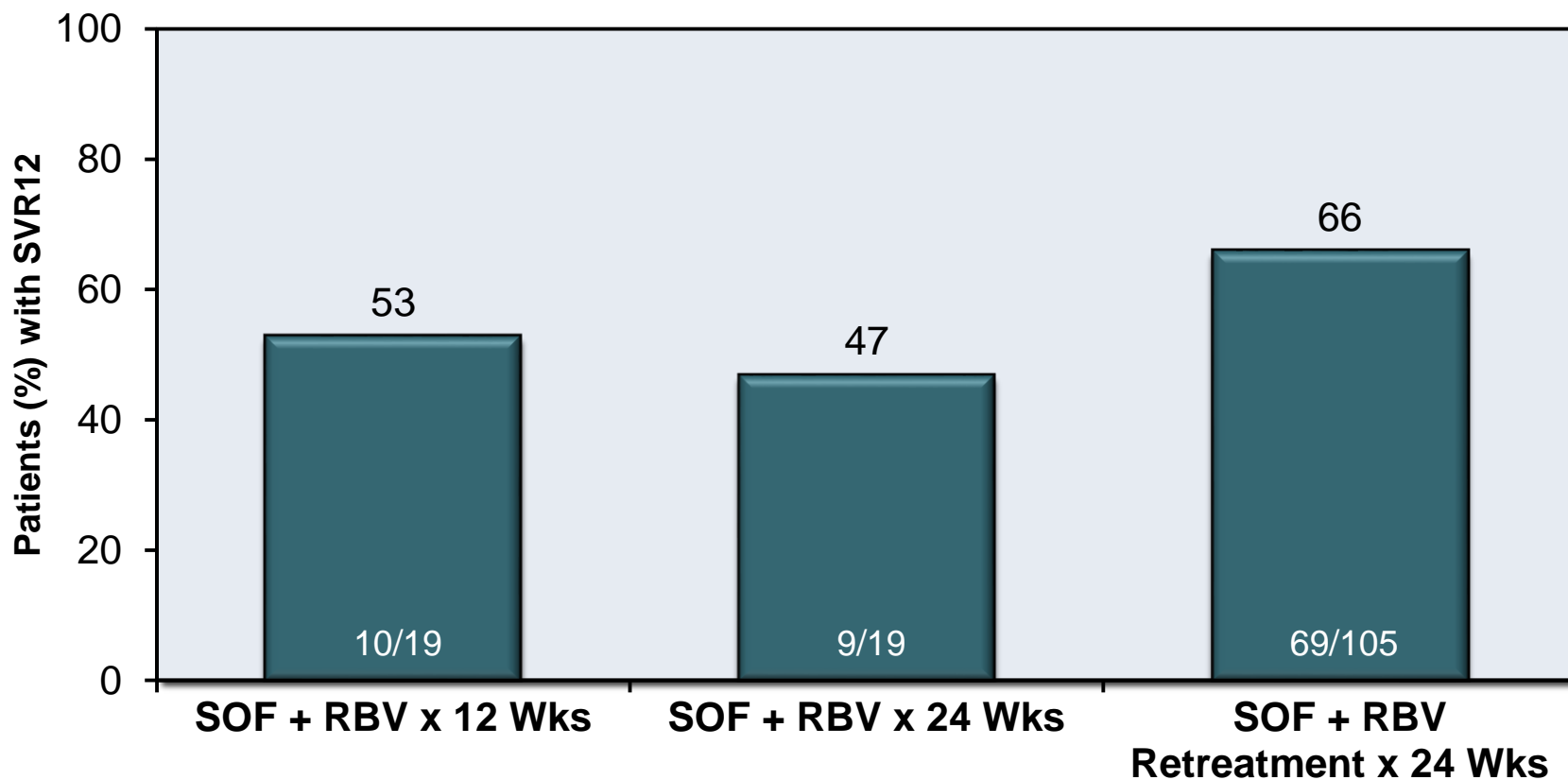

SOF = sofosbuvir; RBV = ribavirin

Source: Lalezari JP, et al. EASL. 2013; Abstract 845.

Sofosbuvir, Ribavirin, & GS-0938 in Treatment Naïve QUANTUM Trial: Results

QUANTUM: SVR12 Results for Patients with Genotype 1

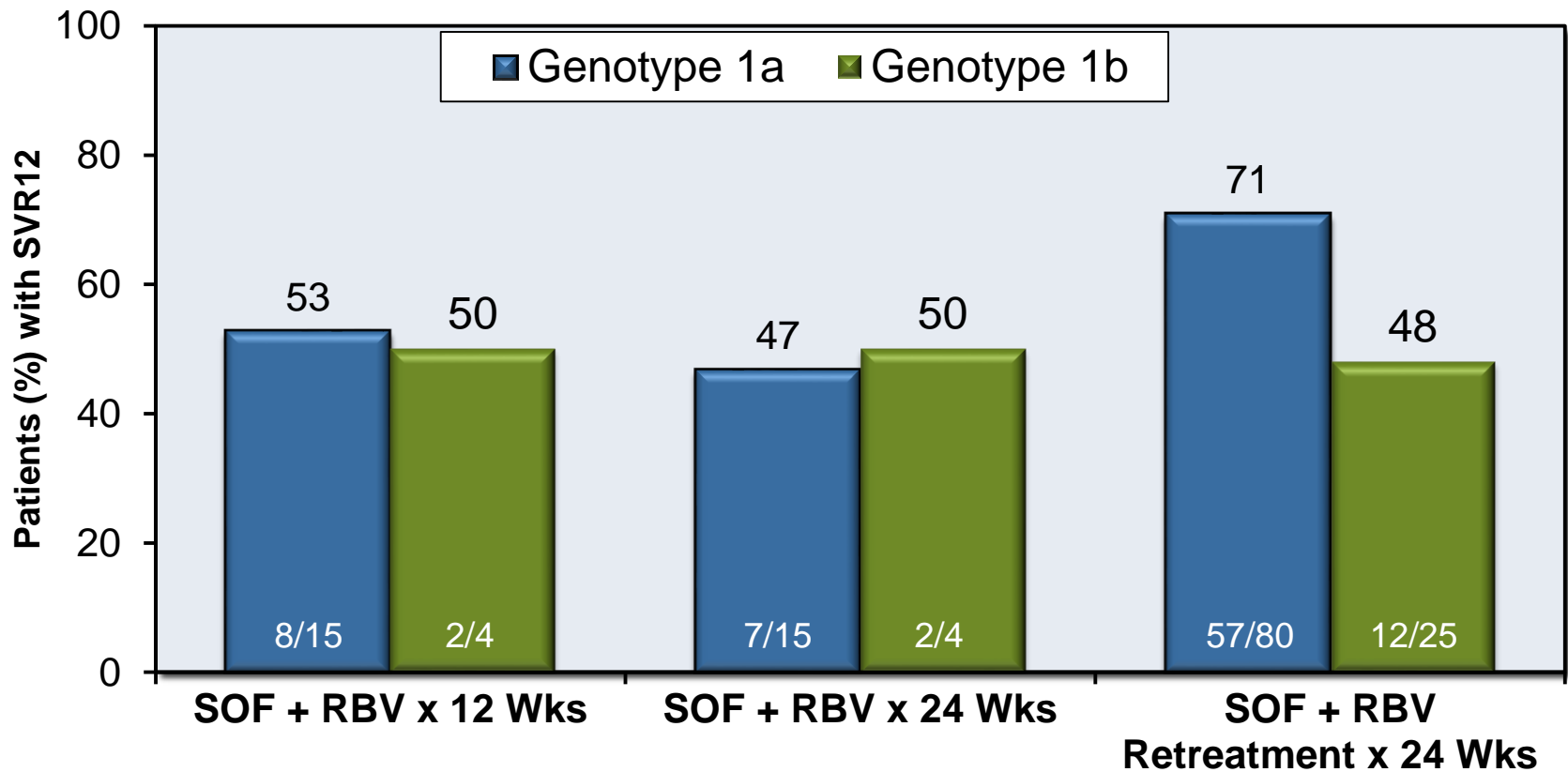

SOF = sofosbuvir; RBV = ribavirin

Source: Lalezari JP, et al. EASL. 2013; Abstract 845.

Sofosbuvir in Treatment-Experienced Patients

Treatment Experienced

Sofosbuvir in Genotype 2 or 3 FUSION Trial

*Note: Published in NEJM in tandem with POSITRON Trial (GT 2,3 Unable to receive PEG)

Jacobson I, et al. N Engl J Med. 2013;368:1867-77.

Sofosbuvir + RBV in Treatment-Experienced HCV GT 2 or 3 FUSION Trial: Features

FUSION Trial: Features

- **Design:** Randomized, controlled, blinded phase 3 trial comparing 12 and 16 weeks of sofosbuvir + ribavirin in treatment-experienced HCV GT 2 or 3
- **Setting:** 67 sites in US, Canada, New Zealand, enrolled May-July 2012
- **Entry Criteria**
 - Treatment-experienced (failed prior interferon-based therapy)
 - HCV RNA \geq 10,000 IU/ml
- **Patient Characteristics**
 - N = 201 HCV-monoinfected patients
 - HCV genotype: 2 (34%); 3 (63%)
 - IL28B genotype: 70% non-CC
 - Prior treatment failure: 75% relapse; 25% nonresponse
 - Age and sex: mean age 54 (range 24-70); 70% male
 - Race: 87% white; 3% black
 - Liver disease: 34% had cirrhosis
- **Primary End-Point:** SVR12

Sofosbuvir + RBV in Treatment-Experienced HCV GT 2 or 3 FUSION Trial: Design

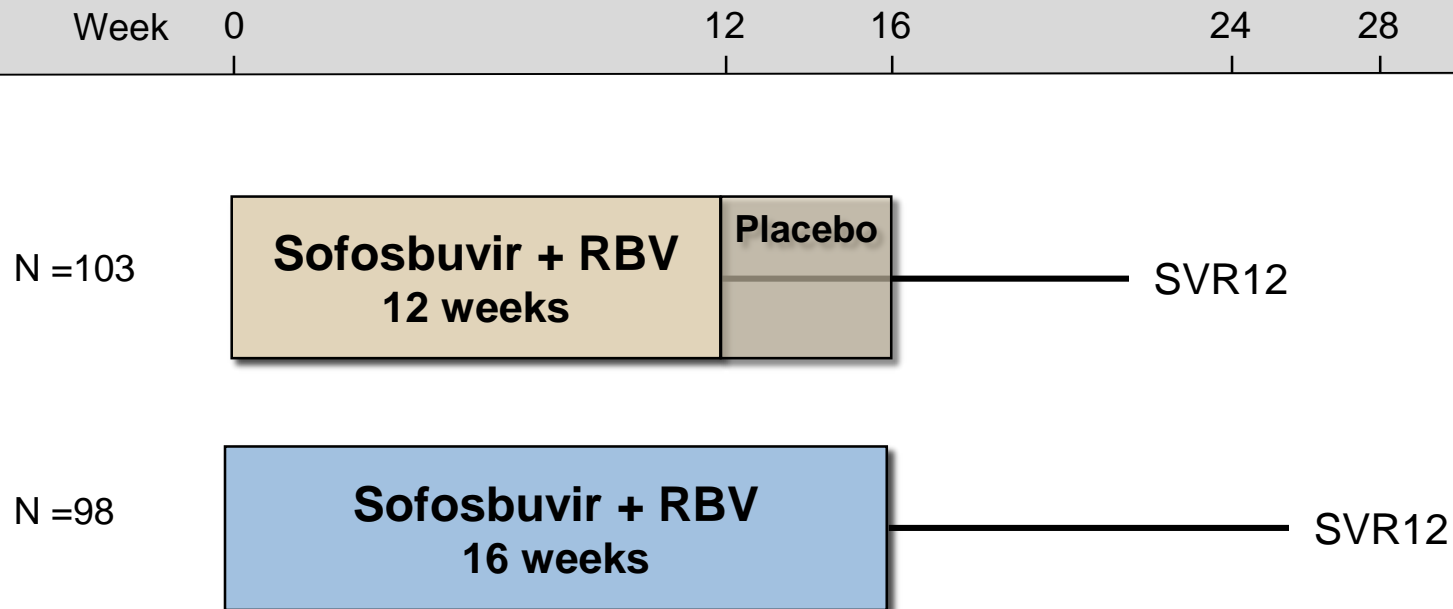

Drug Dosing

Sofosbuvir: 400 mg once daily

Weight-Based Ribavirin (in 2 divided doses): 1000 mg/day if < 75 kg or 1200 mg/day if ≥ 75 kg

Sofosbuvir + RBV in Treatment-Experienced HCV GT 2 or 3 FUSION Trial: Results

FUSION: HCV RNA <25 IU/ml by Study Timepoint

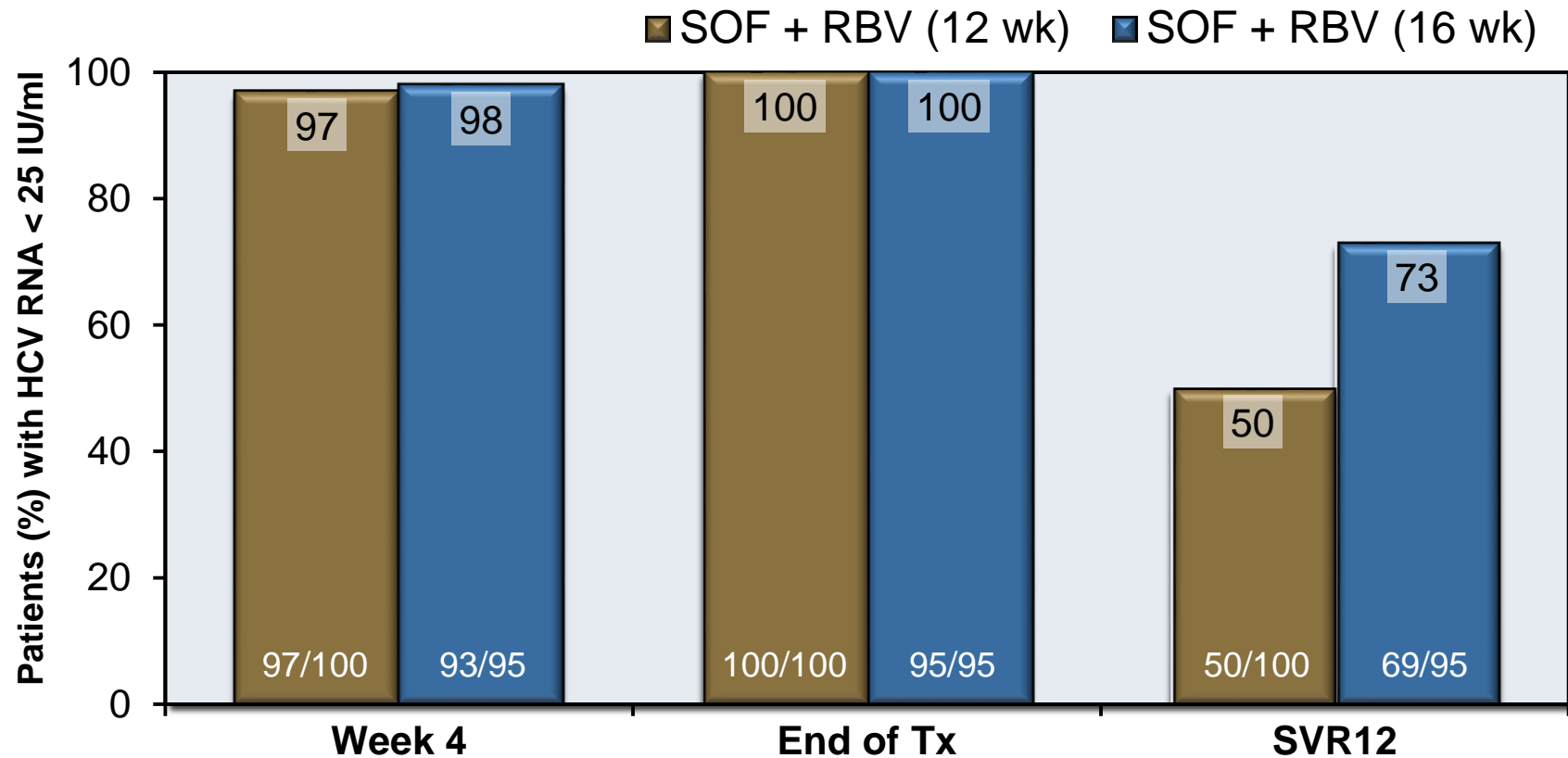

SOF= Sofosbuvir; RBV = Ribavirin

Source: Jacobson I, et al. N Engl J Med. 2013;368:1867-77.

Sofosbuvir + RBV in Treatment-Experienced HCV GT 2 or 3 FUSION Trial: Results

FUSION: SVR12 by Genotype and Treatment Duration

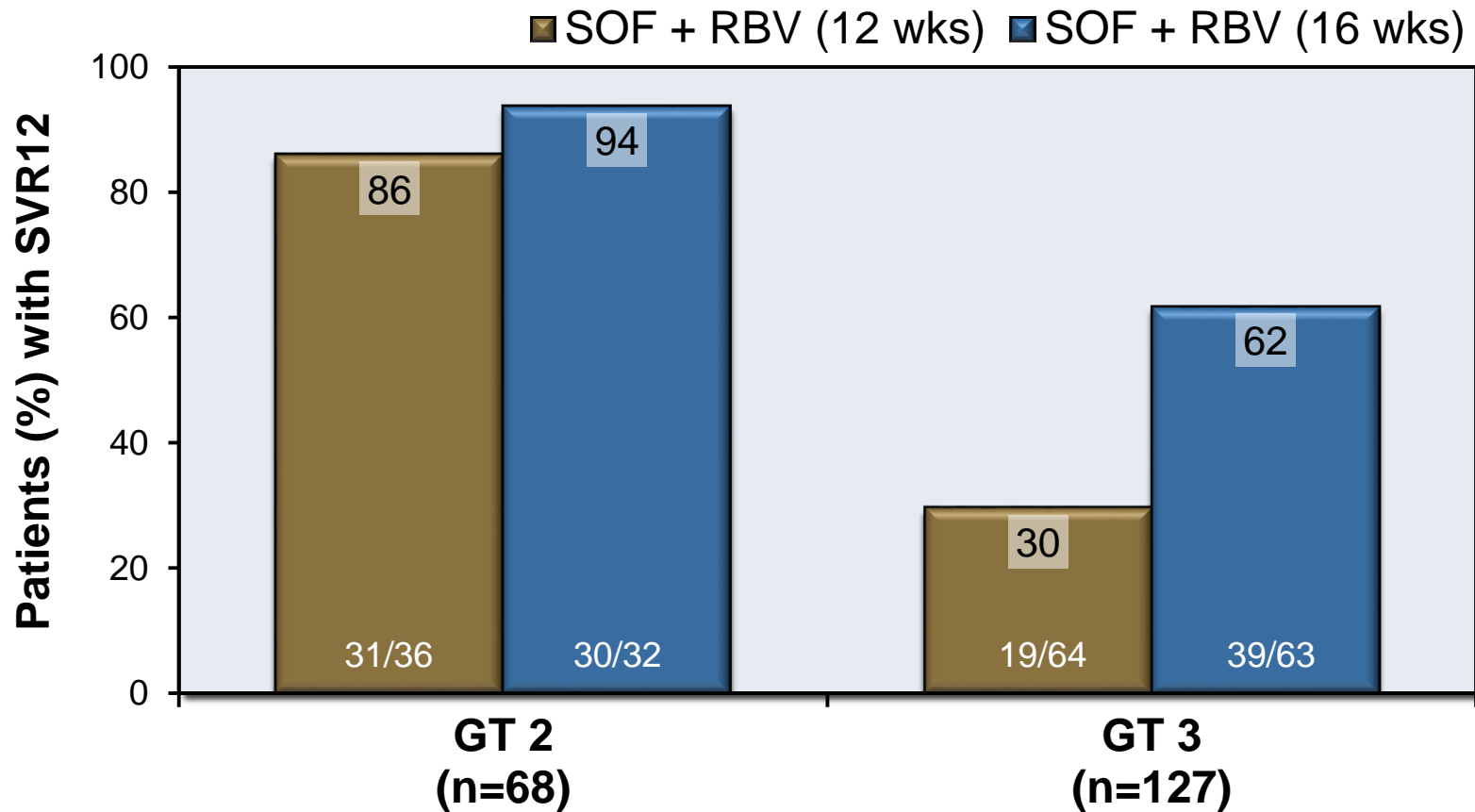

SOF = Sofosbuvir; RBV = Ribavirin

Source: Jacobson I, et al. *N Engl J Med.* 2013;368:1867-77.

Sofosbuvir + RBV in Treatment-Experienced HCV GT 2 or 3 FUSION Trial: Results

FUSION/Genotype 2 and 3: SVR12 by Liver Disease

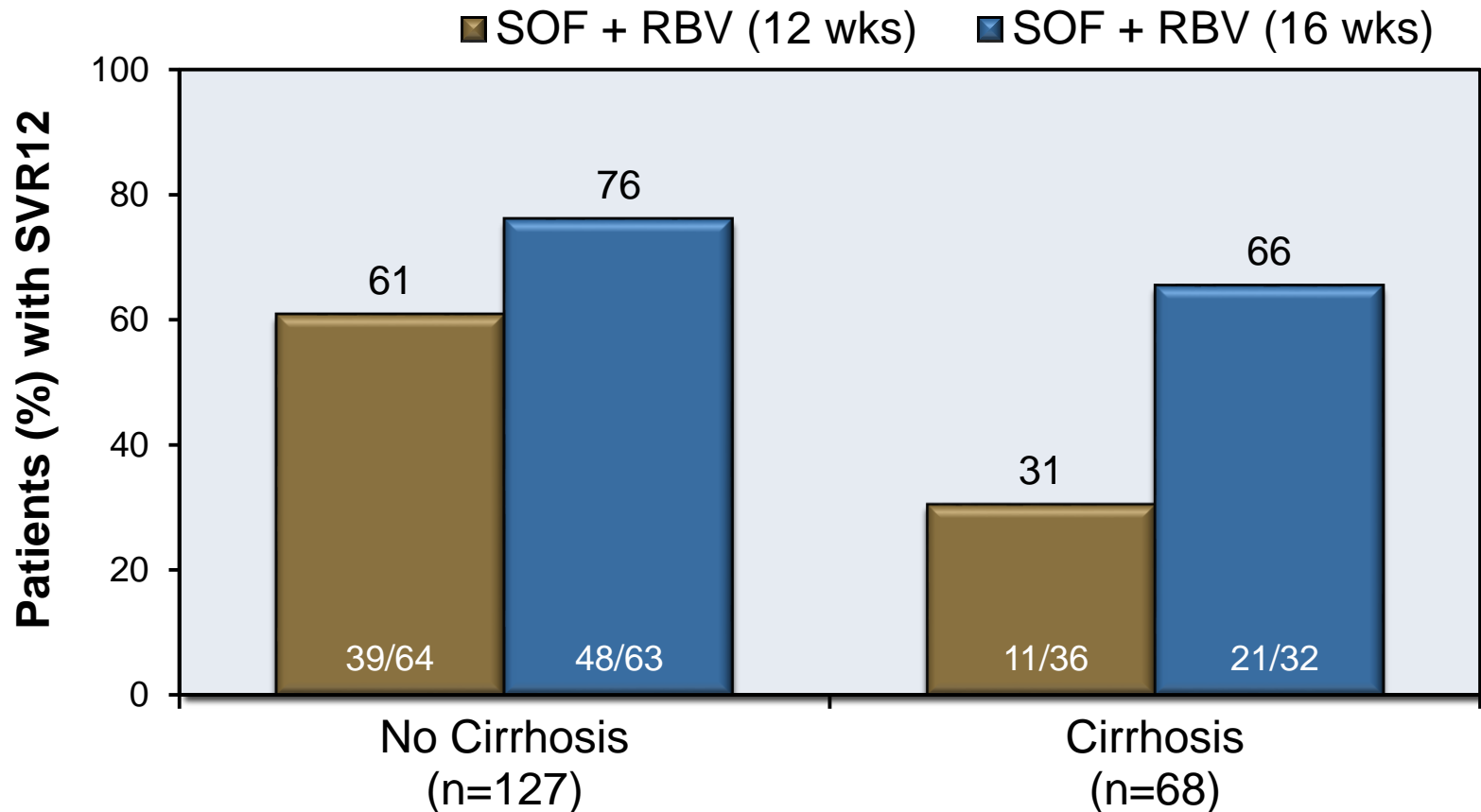

SOF = Sofosbuvir; RBV = Ribavirin

Source: Jacobson I, et al. *N Engl J Med.* 2013;368:1867-77.

Sofosbuvir + RBV in Treatment-Experienced HCV GT 2 or 3 FUSION Trial: Results

FUSION: SVR12 by Genotype, Cirrhosis, and Duration of Therapy

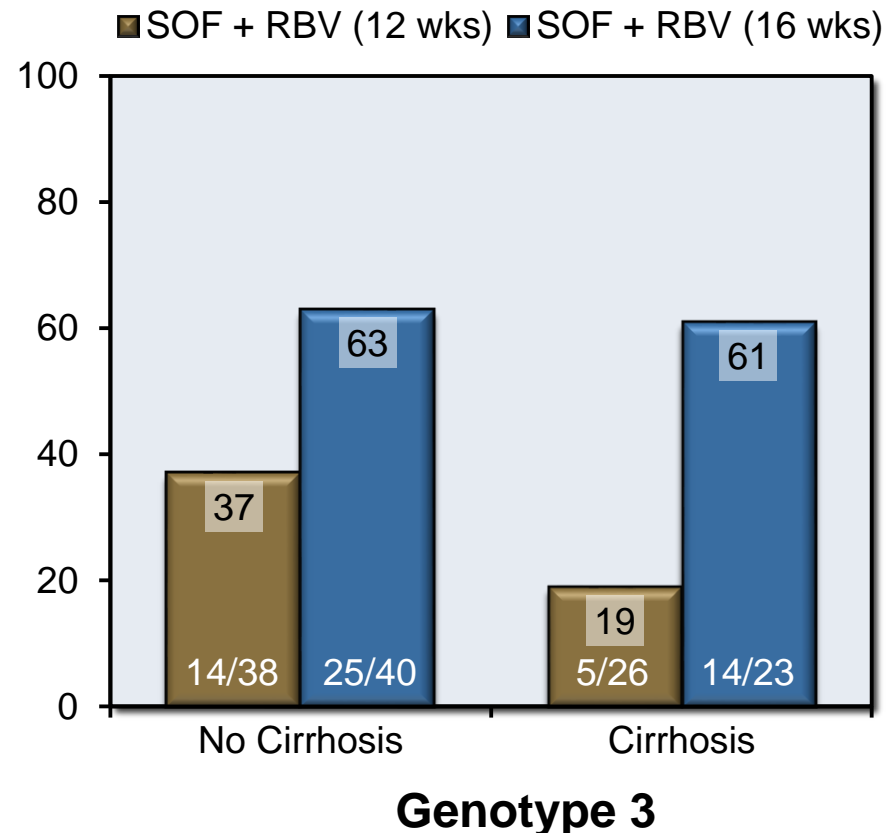
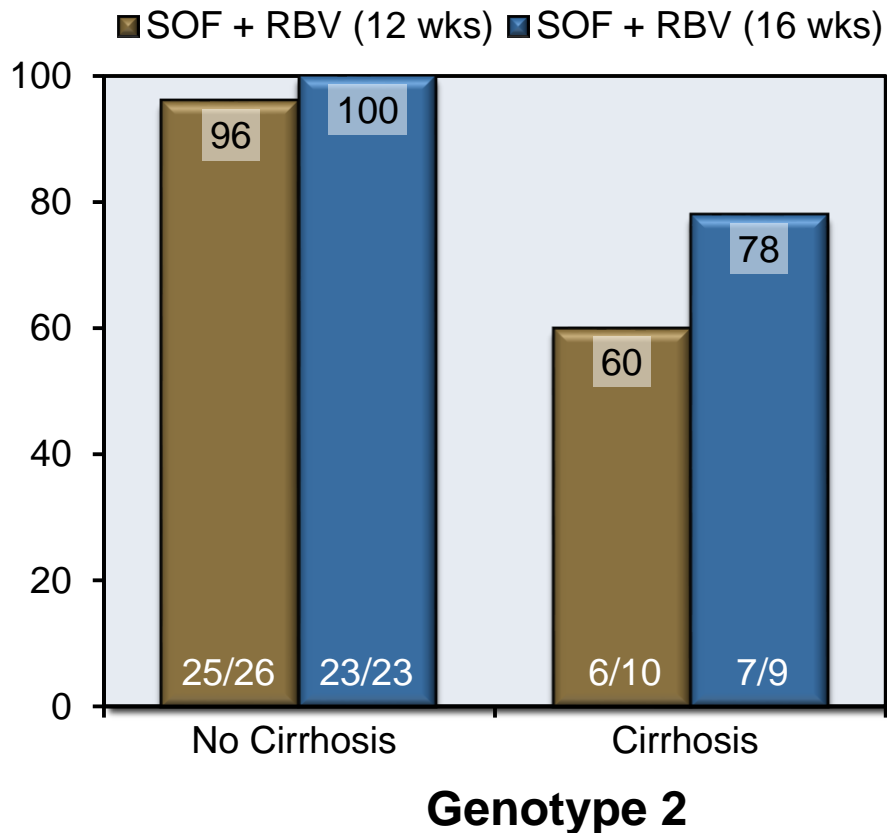

SOF = Sofosbuvir; RBV = Ribavirin

Source: Jacobson I, et al. N Engl J Med. 2013;368:1867-77.

Sofosbuvir + RBV in Treatment-Experienced HCV GT 2 or 3 FUSION Trial: Conclusions

Conclusions: “Our findings suggest that 12 weeks of treatment with sofosbuvir and ribavirin can be an effective option for patients with HCV genotype 2 infection. However, for patients with genotype 3 infection, particularly those who have cirrhosis or who have not had a response to prior treatment with interferon, extending the duration of treatment to 16 weeks may provide an additional benefit.”

*Note: This conclusion pertains to both the **FUSION** and **POSITRON** trials, which were published in tandem

Treatment Experienced

Sofosbuvir + Peginterferon + Ribavirin in Genotype 2 or 3 LONESTAR-2

Lawitz E, et al. Hepatology. 2015;61:769-75.

Sofosbuvir + PEG + RBV in Treatment-Experienced HCV GT 2 or 3

LONESTAR-2 Trial: Features

LONESTAR-2 Trial: Features

- **Design:** Open-label, single-arm, phase 2 trial of 12-week course of sofosbuvir + peginterferon + ribavirin in treatment-experienced patients with HCV GT 2 or 3
- **Setting:** Texas Liver Institute
- **Entry Criteria**
 - N = 47 patients with chronic hepatitis C
 - Previously failed treatment with peginterferon plus ribavirin
 - Excluded if coinfecting with HIV or HBV
 - HCV genotype 2 (49%) or 3 (51%)
 - Compensated cirrhosis allowed
- **Regimen (All x 12 weeks)**
 - Sofosbuvir: 400 mg once daily
 - Peginterferon alfa-2a: 180 µg once weekly
 - Ribavirin (weight based): 1000-1200 mg/day in 2 divided doses
- **Primary End-Point:** SVR12

Sofosbuvir + PEG + RBV in Treatment-Experienced HCV GT 2 or 3 LONESTAR-2 Trial: Patient Demographics

Baseline Characteristic	SOF + PEG + RBV x 12 weeks (n = 47)
Age, mean (range)	56 (39-72)
Male, n (%)	32 (68)
White, n (%)	45 (96)
Hispanic, n (%)	21 (45)
Mean Body Mass Index (BMI) kg/m ² (range)	31 (21-53)
IL28B CC, n (%)	17 (36)
HCV GT3	24 (51)
Mean baseline HCV RNA, log ₁₀ IU/ml (range)	6.2 (4.0-7.2)
Cirrhosis, %	26 (55)
Prior Relapse / virologic breakthrough	40 (85)

Source: Lawitz E, et al. *Hepatology*. 2015;61:769-75.

Sofosbuvir + PEG + RBV in Treatment-Experienced HCV GT 2 or 3 LONESTAR-2 Trial: Design

Week

0

12

24

GT 2 or 3

N = 47

Sofosbuvir +
Peginterferon + Ribavirin

SVR12

Drug Dosing

Sofosbuvir: 400 mg once daily

Peginterferon alfa-2a: 180 µg once weekly

Ribavirin (weight-based and in 2 divided doses): 1000 mg/day if < 75 kg or 1200 mg/day if ≥ 75 kg

Sofosbuvir + PEG + RBV in Treatment-Experienced HCV GT 2 or 3 LONESTAR-2 Trial: Results

SVR12 in Treatment-Experienced by HCV Genotype

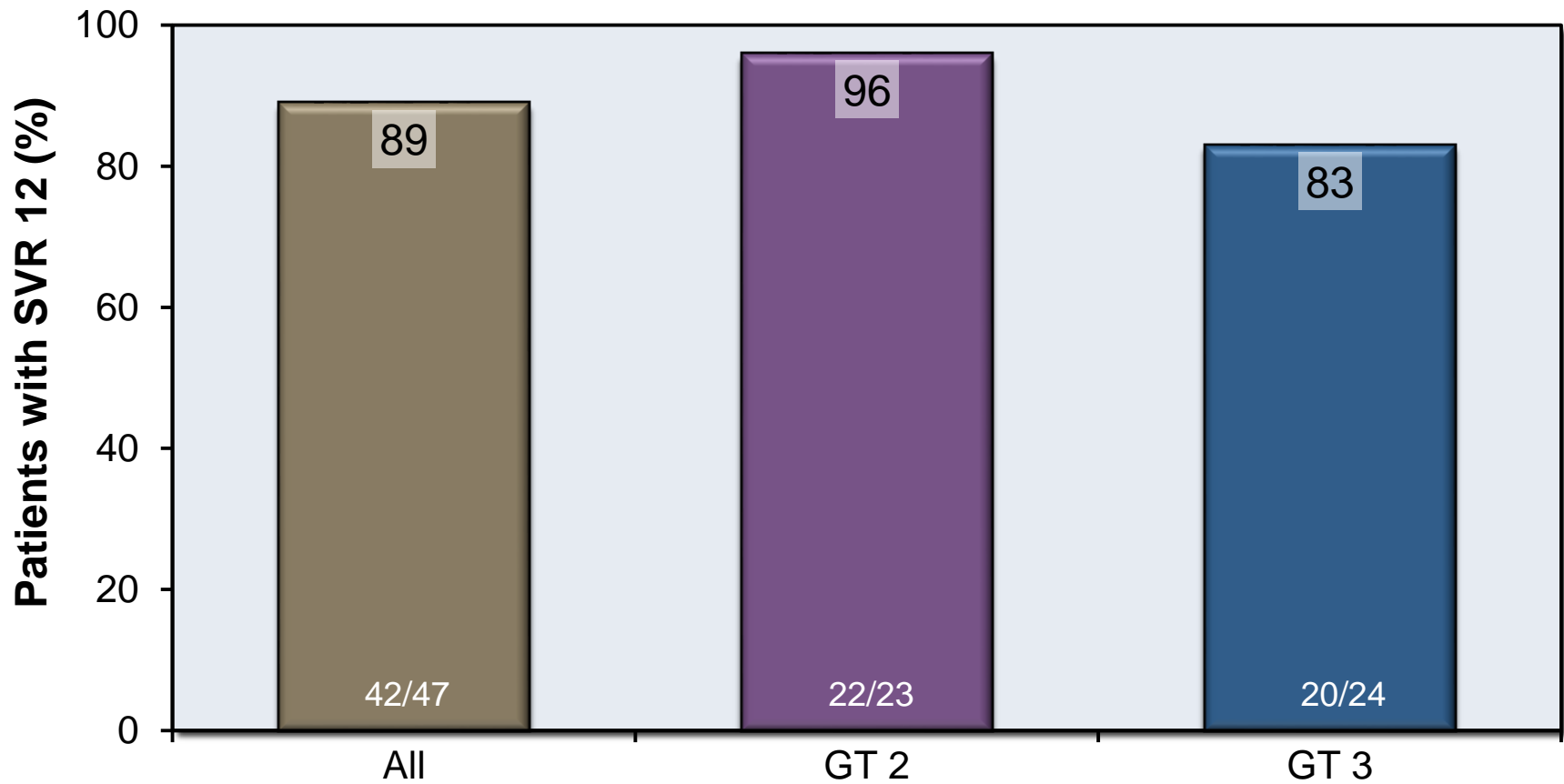

Sofosbuvir + PEG + RBV in Treatment-Experienced HCV GT 2 or 3 LONESTAR-2 Trial: Results

SVR12 in Treatment-Experienced by HCV Genotype

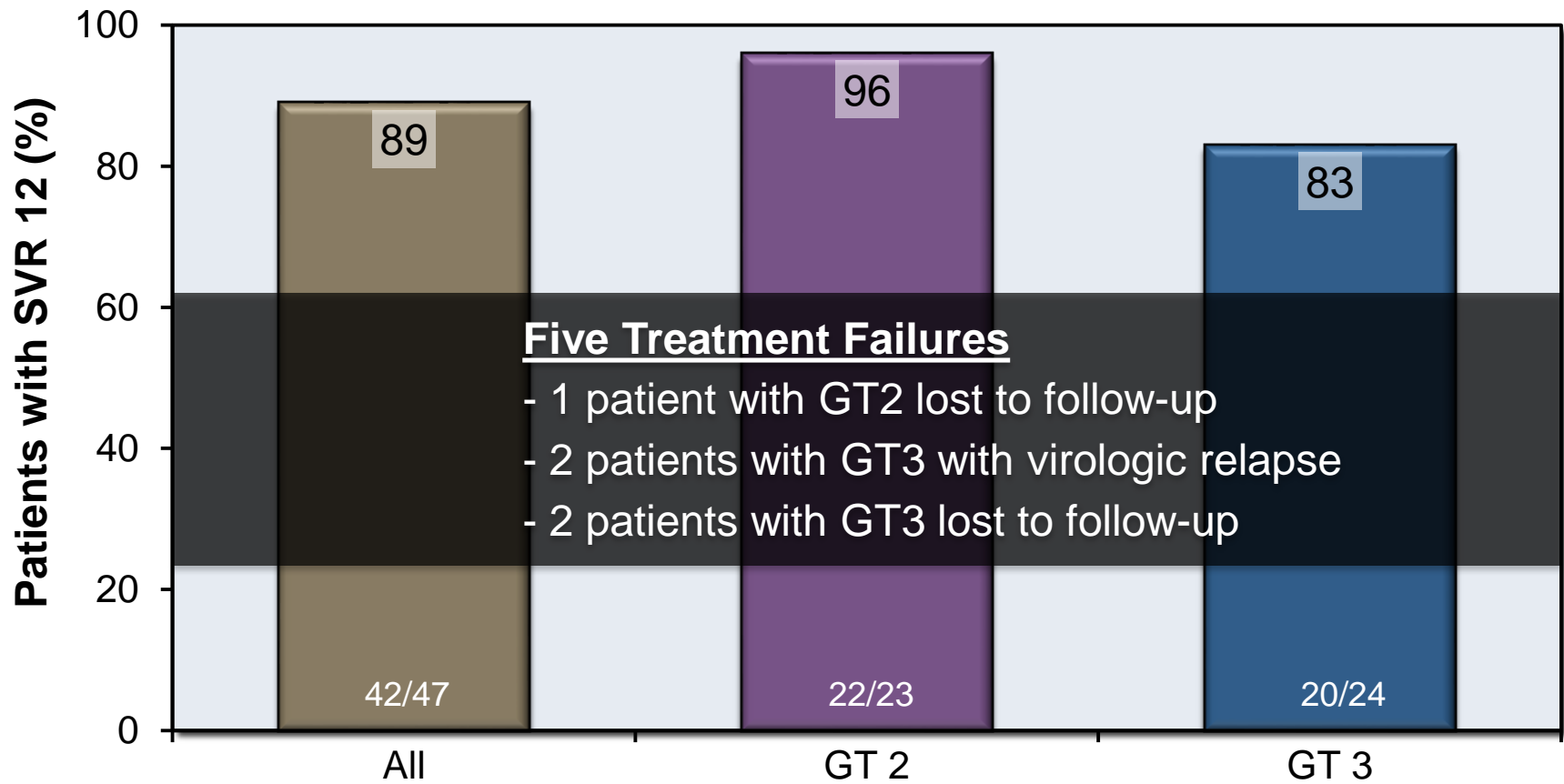

Sofosbuvir + PEG + RBV in Treatment-Experienced HCV GT 2 or 3 LONESTAR-2 Trial: Results

LONESTAR-2 Trial: SVR12 by Cirrhosis Status

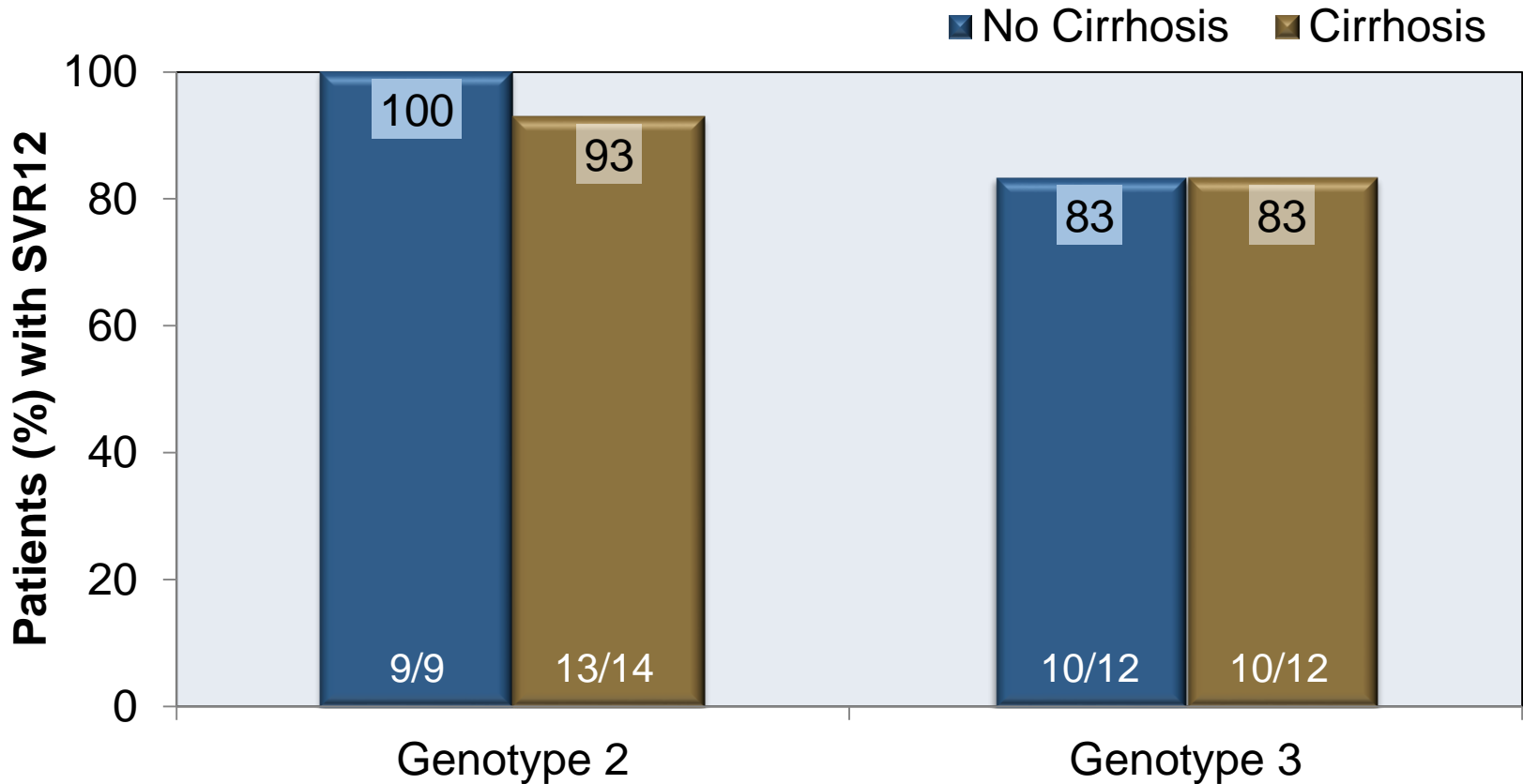

Sofosbuvir + PEG + RBV in Treatment-Experienced HCV GT 2 or 3 LONESTAR-2 Trial: Adverse Events

LONESTAR-2: Adverse Events in $\geq 15\%$ of Patients	
Preferred Term, n (%)	SOF + PEG + RBV x 12 weeks (n = 47)
Any Adverse Event	45 (96)
Flu-like Symptoms	26 (55)
Fatigue	15 (32)
Anemia	14 (30)
Neutropenia	11 (23)
Nausea	8 (17)
Headache	7 (15)
Rash	7 (15)
Thrombocytopenia	7 (15)

Sofosbuvir + PEG + RBV in Treatment-Experienced HCV GT 2 or 3 LONESTAR-2 Trial: Conclusion

Conclusions: “In treatment-experienced patients with HCV genotypes 2 and 3, 12-week administration of sofosbuvir + peginterferon + ribavirin provided high SVR rates, irrespective of cirrhosis status. No safety concerns were identified.”

Treatment Experienced (with Sofosbuvir and Ribavirin)

Retreatment of Sofosbuvir + Ribavirin Failure with Sofosbuvir-Containing Regimens in Patients with Genotype 2 or 3

Esteban R, et al. 49th EASL; April 2014. Abstract 08.

Retreatment of SOF + RBV Failure with SOF-Containing Regimens in GT 2 or 3 Study Features

Retreatment of Sofosbuvir + Ribavirin Failure: Features

- **Design:** Open-label, non-randomized study for patients with GT 2 or 3 who had failure with sofosbuvir + ribavirin in FISSION, POSITRON, or FUSION trial
- **Setting:** Europe, United States, and Canada
- **Entry Criteria**
 - N = 107 patients with chronic HCV
 - HCV genotype 2 (10%) or HCV genotype 3 (90%)
 - Previous relapse on sofosbuvir plus ribavirin
 - Patients with compensated cirrhosis allowed to enroll
- **Regimens (patients offered 2 possible regimens)**
 - Sofosbuvir + Ribavirin x 24 weeks
 - Sofosbuvir + Peginterferon + Ribavirin x 12 weeks
- **Primary End-Point:** SVR12

Retreatment of SOF + RBV Failure with SOF-Containing Regimens in GT 2 or 3 Baseline Characteristics

Baseline Characteristic	SOF + PEG + RBV x 12 weeks (n = 34)	SOF + RBV x 24 weeks (n = 73)
Age, mean (range)	53 (31-70)	53 (38-63)
Male, n (%)	26 (77%)	63 (86%)
White, n (%)	1 (1%)	0
Mean BMI kg/m ² (range)	29 (22-39)	28 (20-41)
Cirrhosis, %	14 (41%)	25 (34%)
IL28B CC, n (%)	11 (32%)	27 (37%)
Genotype, n (%)		
2	6 (18%)	5 (7%)
3	28 (82%)	68 (93%)
Mean baseline HCV RNA, log ₁₀ IU/ml (range)	6.3 (4.8-7.8)	6.6 (4.4-7.6)

Retreatment of SOF + RBV Failure with SOF-Containing Regimens in GT 2 or 3 Study Design

Week 0 12 24 36

**GT2
or
GT3**

N = 34

**Sofosbuvir +
PEG + RBV**

SVR12

N = 73

Sofosbuvir + RBV

SVR12

Drug Dosing

Sofosbuvir: 400 mg once daily

Peginterferon alfa-2a: 180 µg once weekly

Weight-based Ribavirin (in 2 divided doses): 1000 mg/day if < 75 kg or 1200 mg/day if ≥ 75 kg

Retreatment of SOF + RBV Failure with SOF-Containing Regimens in GT 2 or 3 Results, by Genotype

SVR12 by Regimen and HCV Genotype

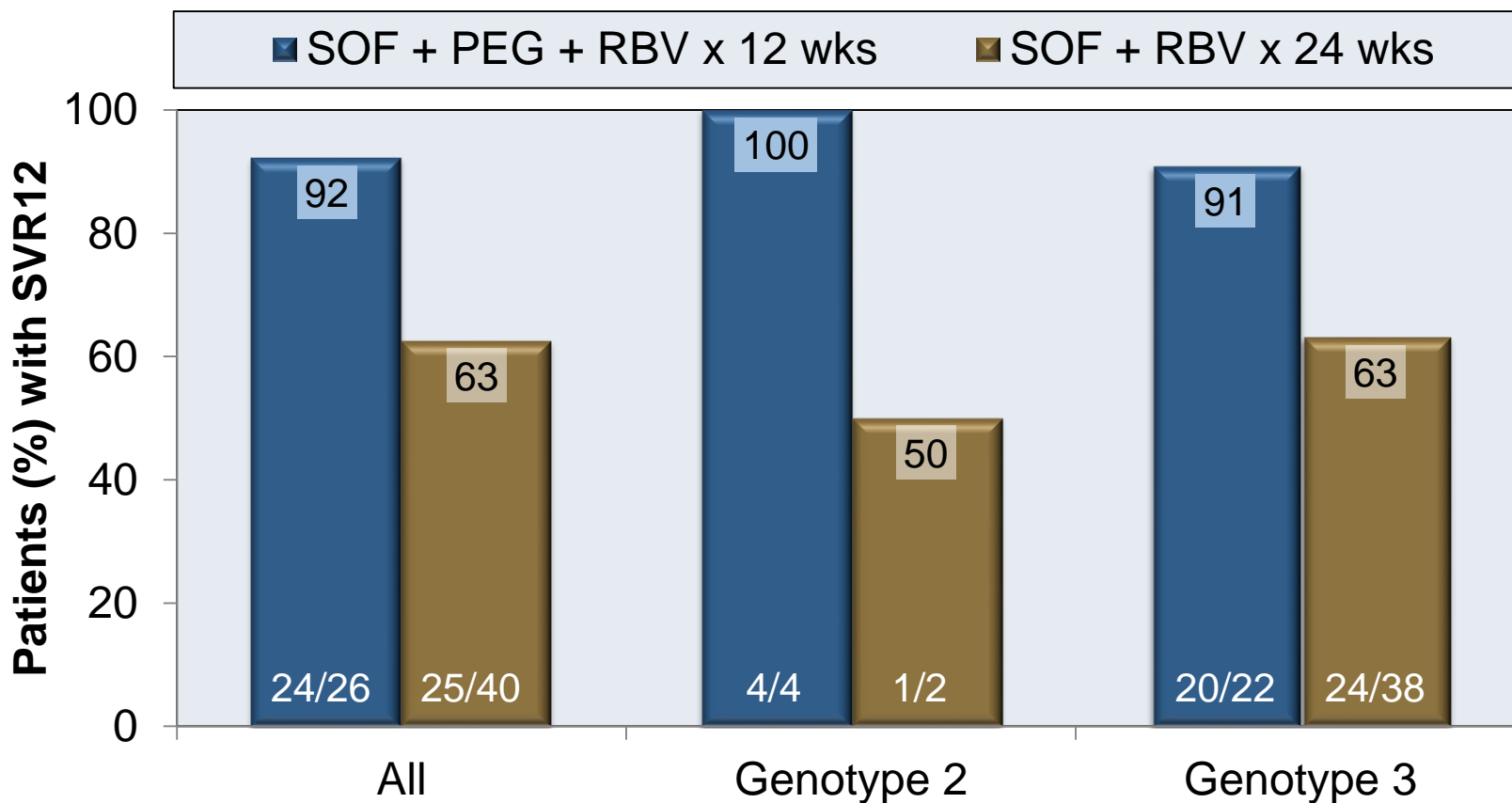

Retreatment of SOF + RBV Failure with SOF-Containing Regimens in GT 2 or 3 Results, by Genotype

SVR12 by Regimen and Presence or Absence of Cirrhosis

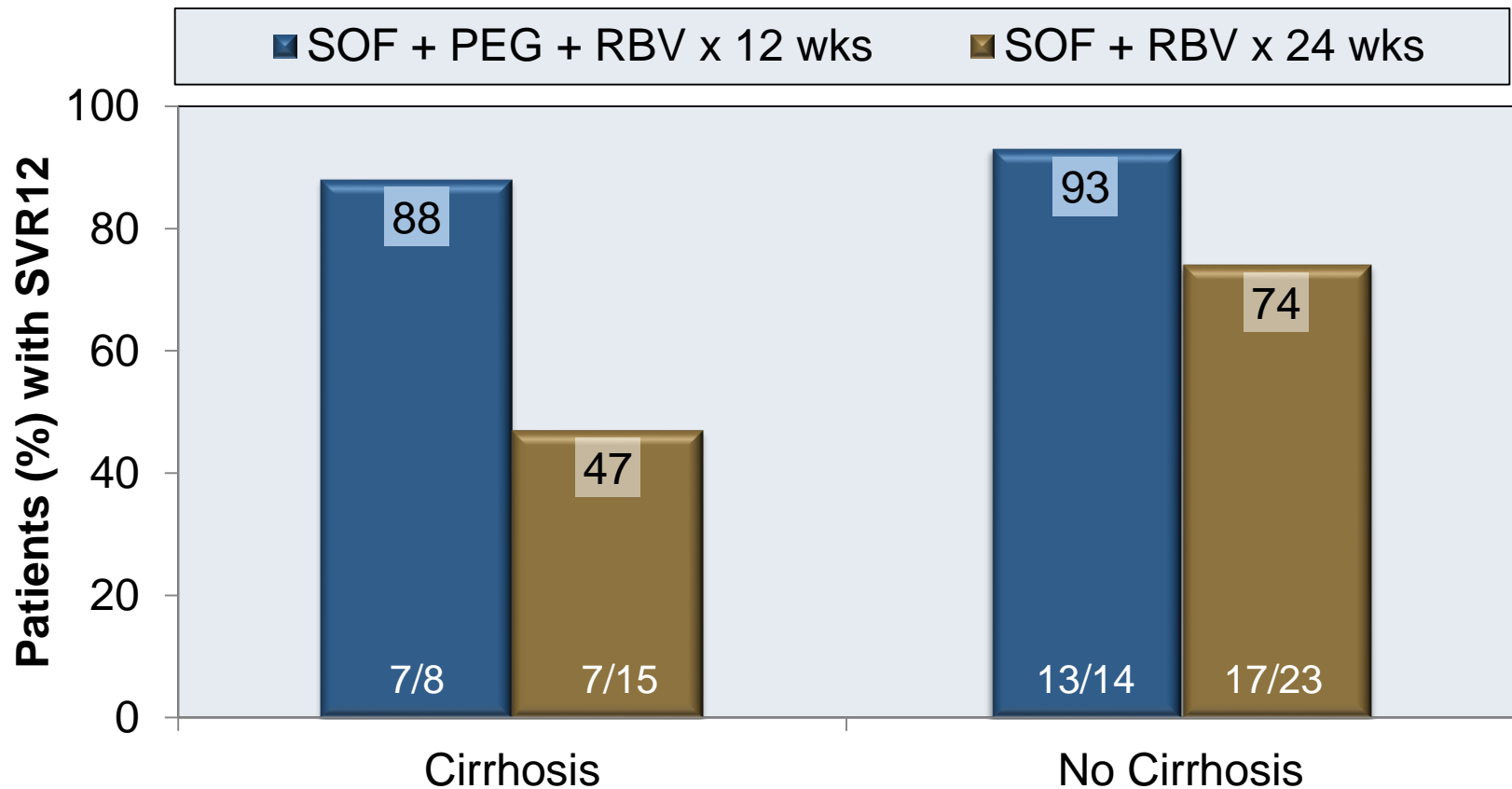

Sofosbuvir in Treatment-Naïve and Treatment-Experienced Patients

Treatment Naïve and Treatment Experienced (Interferon Intolerant, Unwilling, or Ineligible)

Sofosbuvir in HCV Genotype 2, 3 (PEG not an Option) POSITRON

*Note: Published in tandem with **FUSION** Trial (GT 2,3 and prior failure with PEG)

Jacobson I, et al. N Engl J Med. 2013;368:1867-77.

Sofosbuvir + Ribavirin for HCV GT 2 or 3 (PEG not an option) POSITRON Trial: Design

POSITRON: Study Features

- **Design:** Randomized, double-blind, placebo-controlled, phase 3 trial of sofosbuvir + ribavirin versus placebo in patients with HCV GT 2 or 3
- **Setting:** 63 sites in US, Canada, Australia, New Zealand, enrolled March-May 2012
- **Entry Criteria**
 - Interferon intolerant with prior treatment, ineligible, or unwilling
- **Patient Characteristics**
 - N = 278 HCV-monoinfected patients
 - HCV Genotype: 2 (51%), 3 (49%)
 - IL28B Genotype: 55% non-CC
 - Age and Sex: 52 (range 21-75); 54% male
 - Race: 91% white; 5% black
 - Liver disease: 16% had cirrhosis
- **Primary End-Point:** SVR12

Sofosbuvir + Ribavirin for HCV GT 2 or 3 (PEG not an option) POSITRON Trial: Design

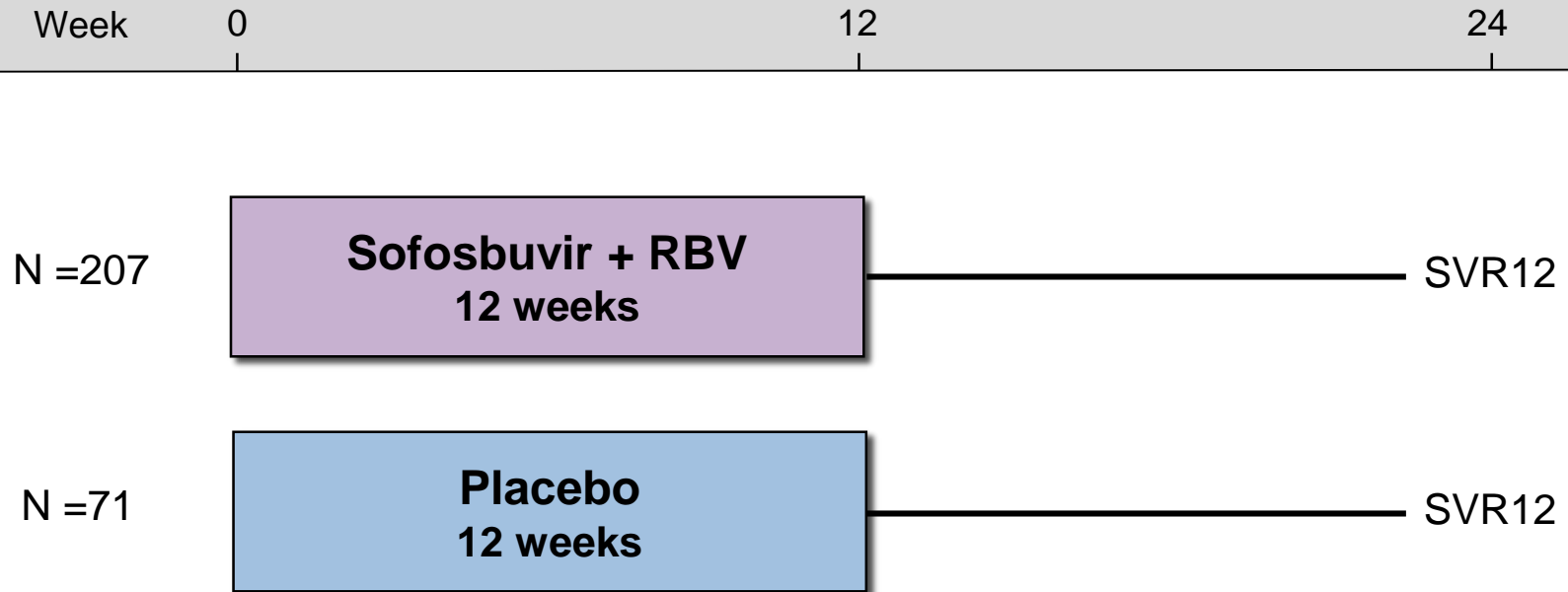

Drug Dosing

Sofosbuvir: 400 mg once daily

Weight-Based Ribavirin (in 2 divided doses): 1000 mg/day if < 75 kg or 1200 mg/day if ≥ 75 kg

Sofosbuvir + Ribavirin for HCV GT 2 or 3 (PEG not an option) POSITRON Trial: Reasons for Interferon Ineligibility

Interferon Category	Sofosbuvir + RBV (n=207)	Placebo (n=71)
Ineligible	43%	46%
Intolerant	8%	11%
Unwilling	49%	42%

Sofosbuvir + Ribavirin for HCV GT 2 or 3 (PEG not an option) POSITRON Trial: Duration on Prior Interferon

Interferon Category	Sofosbuvir + RBV (n=207)	Placebo (n=71)
None	82%	79%
≤ 12 weeks	10%	11%
> 12 weeks	8%	10%

Sofosbuvir for HCV Infection GT 2,3 (PEG not an option) POSITRON: Results with Sofosbuvir + Ribavirin

POSITRON: Patients with HCV RNA <25 IU/ml by Study Timepoint

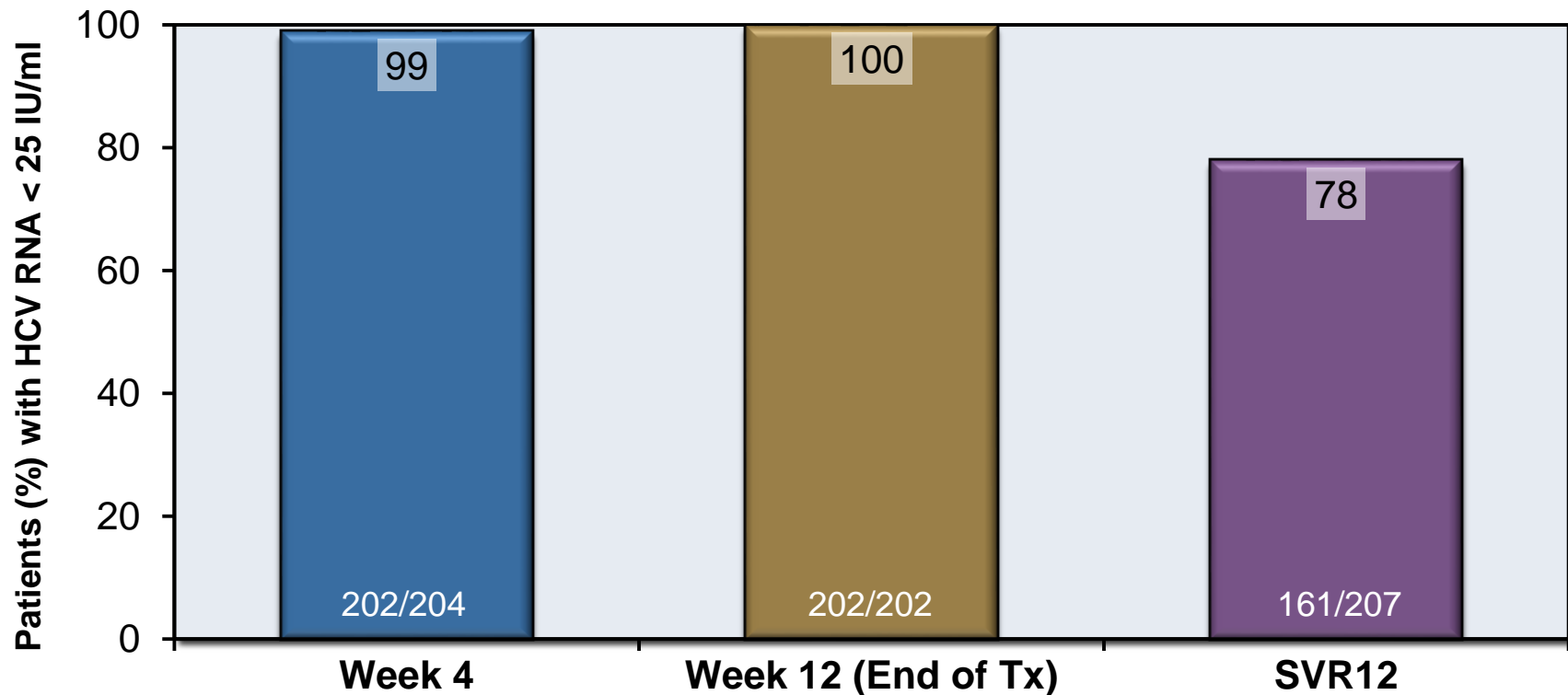

Placebo arm: 0% for each timepoint

Abbreviations: SOF = sofosbuvir; RBV = ribavirin

Source: Jacobson I, et al. N Engl J Med. 2013;368:1867-77.

Sofosbuvir + Ribavirin for HCV GT 2,3 (PEG not an option) POSITRON: Results with Sofosbuvir + Ribavirin

POSITRON: SVR12 by HCV Genotype

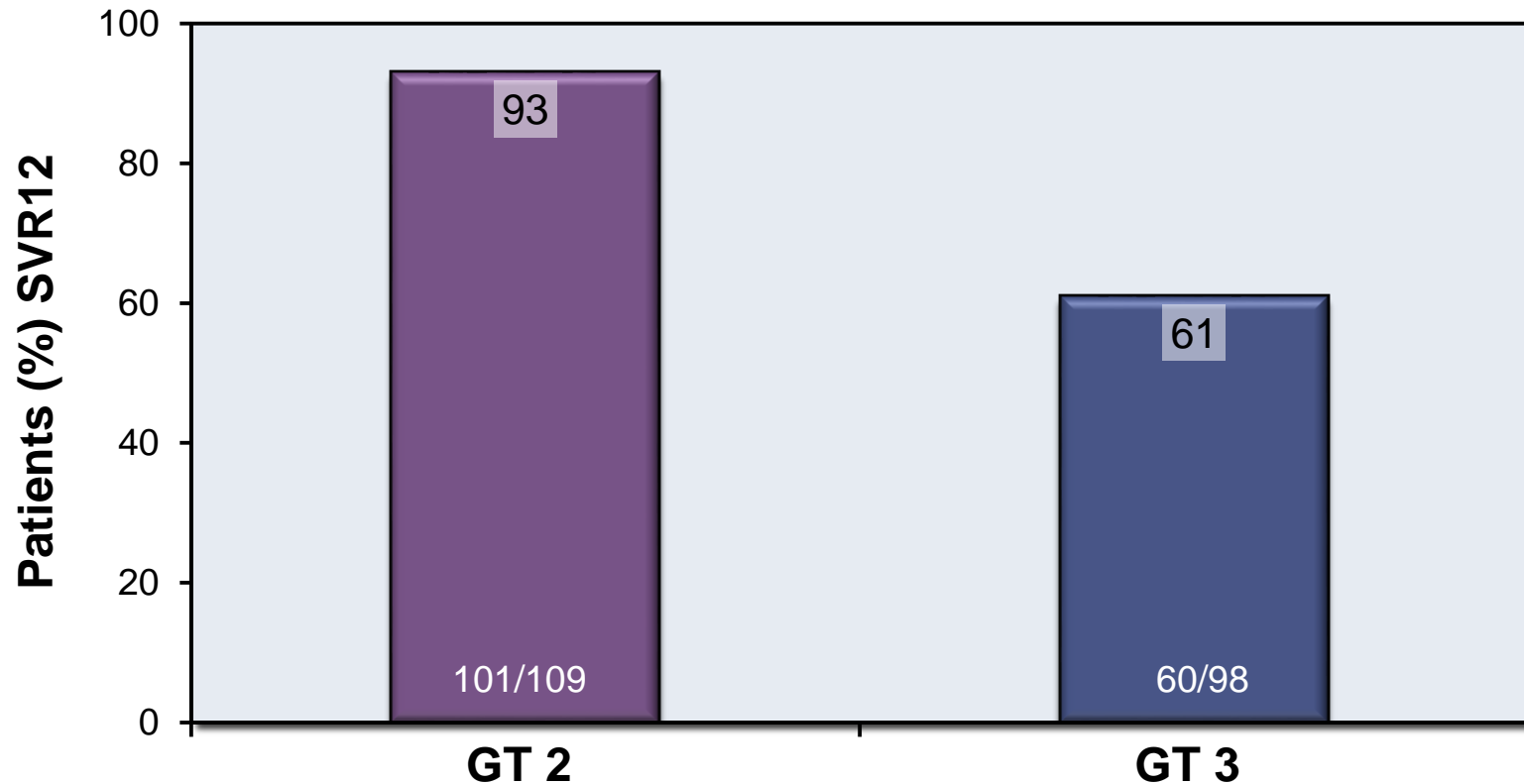

Placebo arm: 0% for each timepoint

Source: Jacobson I, et al. *N Engl J Med.* 2013;368:1867-77.

Sofosbuvir + Ribavirin for HCV GT 2,3 (PEG not an option) POSITRON: Results with Sofosbuvir + Ribavirin

POSITRON: SVR12 by Liver Disease

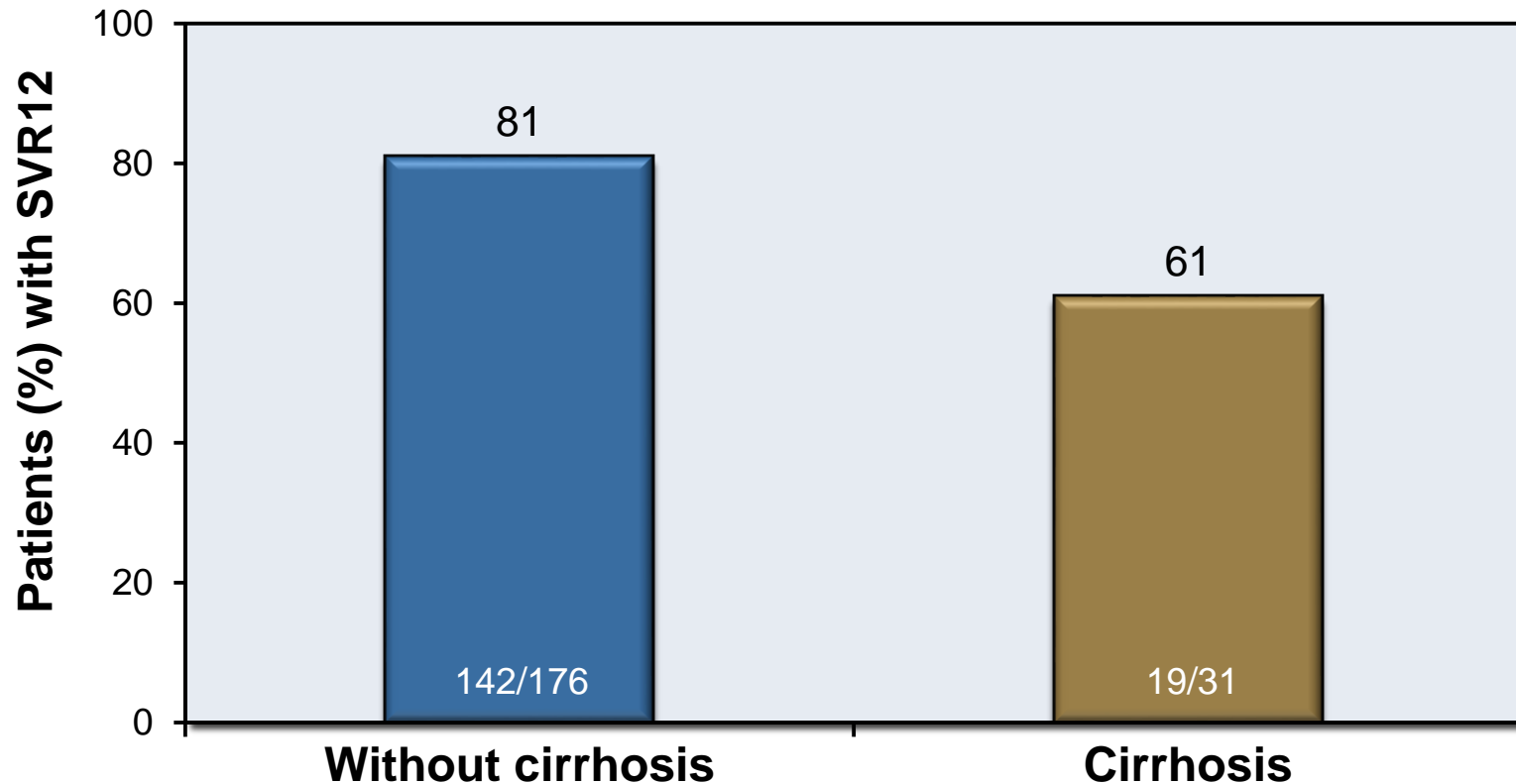

Placebo arm: 0% for each timepoint

Source: Jacobson I, et al. N Engl J Med. 2013;368:1867-77.

Sofosbuvir + Ribavirin for HCV GT 2,3 (PEG not an option) POSITRON: Results with Sofosbuvir + Ribavirin

POSITRON: SVR12 by Liver Disease and Genotype

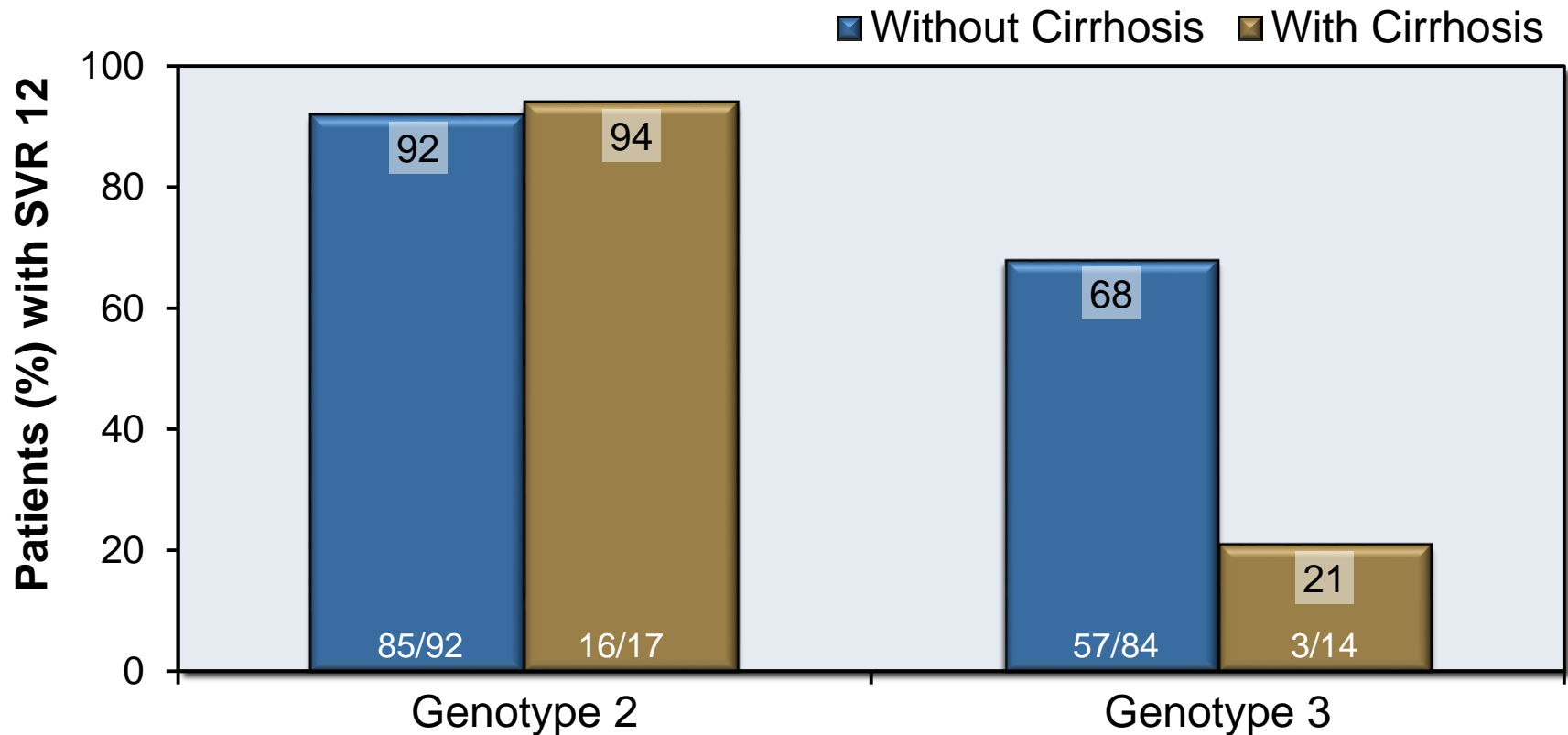

Placebo arm: 0% for each timepoint

Source: Jacobson I, et al. N Engl J Med. 2013;368:1867-77.

Sofosbuvir + Ribavirin for HCV GT 2,3 (PEG not an option) POSITRON Trial: Conclusions

Conclusion*: “In patients with HCV genotype 2 or 3 infection for whom treatment with peginterferon and ribavirin was not an option, 12 [or 16] weeks of treatment with sofosbuvir and ribavirin was effective. Efficacy was increased among patients with HCV genotype 2 infection and those without cirrhosis.”

*Note: This conclusion pertains to both the **POSITRON** and **FUSION** trials, which were published in tandem

Treatment Naïve and Treatment Experienced

Sofosbuvir + Additional Agents ELECTRON (Overview): 6 parts, 22 arms

Source: [Clinical Trials.gov](https://clinicaltrials.gov)

Sofosbuvir

Summary of ELECTRON Trials Design (1 of 2)

- **Part 1**
 - Arm 1: Sofosbuvir + Ribavirin x 12 weeks (GT 2,3; naive)
 - Arm 2: Sofosbuvir + Ribavirin x 12 weeks + Peginterferon for weeks 1-4 (GT 2,3; naive)
 - Arm 3: Sofosbuvir + Ribavirin x 12 weeks + Peginterferon for weeks 1-8 (GT 2,3; naive)
 - Arm 4: Sofosbuvir + Ribavirin + Peginterferon x 12 weeks (GT 2,3; naive)
- **Part 2**
 - Arm 5: Sofosbuvir x 12 weeks (GT 2,3; naive)
 - Arm 6: Sofosbuvir + Ribavirin + Peginterferon x 8 weeks (GT 2,3; naive)
 - Arm 7: Sofosbuvir + Ribavirin x 12 weeks (GT 1; experienced null)
- **Part 3**
 - Arm 8: Sofosbuvir + Ribavirin x 12 weeks (GT 1; naive)
 - Arm 9: Sofosbuvir + Ribavirin x 12 weeks (GT 2,3; experienced)
- **Part 4**
 - Arm 10: Sofosbuvir + Ribavirin x 8 weeks (GT 2,3; naive)
 - Arm 11: Sofosbuvir + Ribavirin x 12 weeks (GT 2,3; naive)
 - Arm 12: Sofosbuvir + Ledipasvir + Ribavirin x 12 weeks (GT 1, experienced null)
 - Arm 13: Sofosbuvir + Ledipasvir + Ribavirin x 12 weeks (GT 1, naive)

Sofosbuvir

Summary of ELECTRON Trials Design (2 of 2)

- **Part 5**
 - Arm 14: Sofosbuvir + GS-9669 + Ribavirin x 12 weeks (GT 1; experienced null)
 - Arm 15: Sofosbuvir + GS-9669 + Ribavirin x 12 weeks x 12 weeks (GT 1; naive)
- **Part 6**
 - Arm 16: Sofosbuvir-Ledipasvir x 12 weeks (GT 1; experienced null; F4)
 - Arm 17: Sofosbuvir-Ledipasvir + Ribavirin x 12 weeks (GT 1; experienced null; F4)
 - Arm 18: Sofosbuvir-Ledipasvir x 12 weeks x 12 weeks (GT 2,3, naive)
 - Arm 19: Sofosbuvir-Ledipasvir x 12 weeks x 12 weeks (GT 2,3, experienced)
 - Arm 20: Sofosbuvir-Ledipasvir + Ribavirin x 12 weeks (GT 1, naïve, hemophiliacs)
 - Arm 21: Sofosbuvir-Ledipasvir + Ribavirin x 6 weeks (GT 1, naive)
 - Arm 22: Sofosbuvir-Ledipasvir x 6 weeks (GT 1, naive)

Treatment Naïve and Treatment Experienced

Sofosbuvir and Ribavirin +/- Peginterferon in GT 1-3 ELECTRON Trial (Arms 1-8)

Gane EJ, et al. N Engl J Med. 2013;368:34-44.

Sofosbuvir and Ribavirin +/- Peginterferon in GT 1-3 ELECTRON Trial (Arms 1-8): Features

ELECTRON Trial (Arms 1-8): Features

- **Design:** Randomized, double-blind, phase 2a trial comparing different combinations of sofosbuvir and ribavirin with or without peginterferon
- **Setting:** 2 hepatitis C treatment centers in New Zealand
- **Entry Criteria**
 - HCV RNA > 50,000 IU/mL
 - No cirrhosis
- **Study Arms**
 - Arms 1-6: genotype 2,3 treatment naïve: SOF + RBV +/- PEG
 - Arm 7: GT 1; treatment experienced, prior null responder: SOF + RBV
 - Arm 8: GT 1; treatment naïve: SOF + RBV
- **Primary End-Point:** SVR12

Sofosbuvir and Ribavirin +/- Peginterferon in GT 1-3 ELECTRON Trial (Arms 1-8): Design

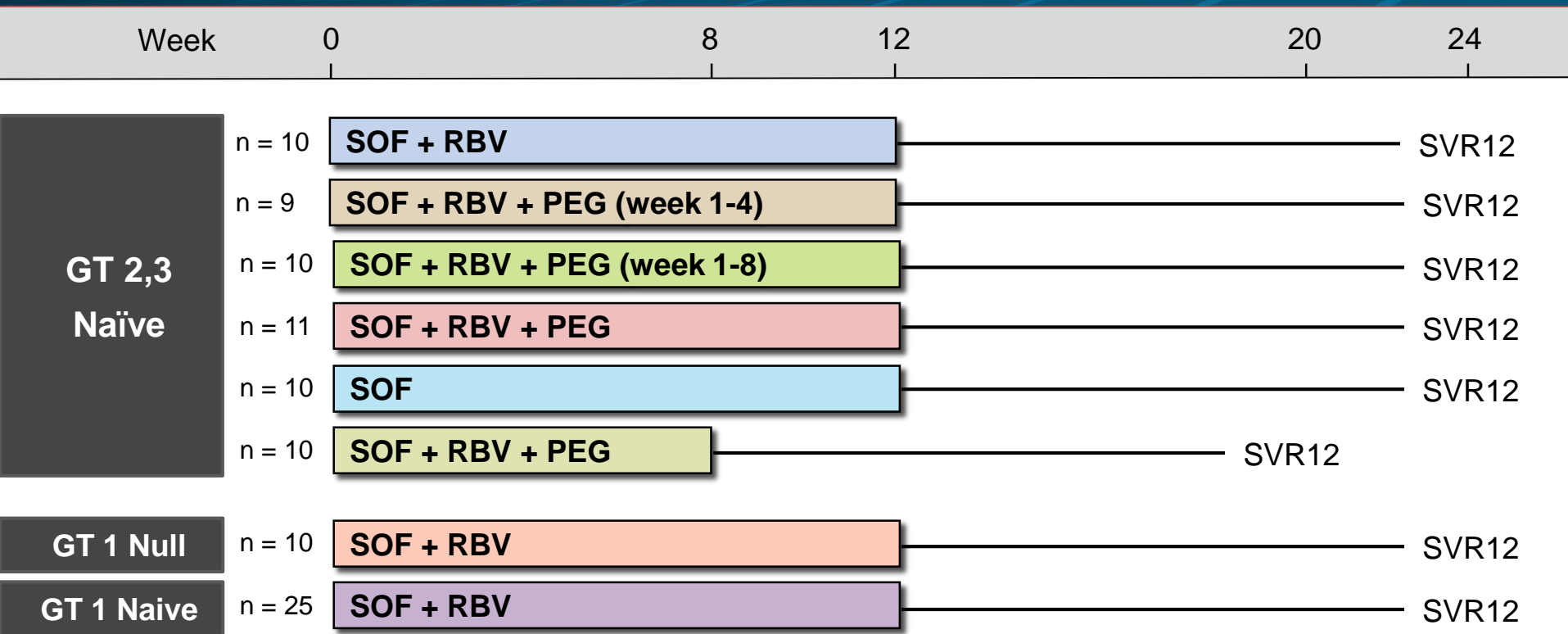

Drug Dosing

Sofosbuvir (SOF): 400 mg once daily

Ribavirin (RBV) weight-based and divided bid: 1000 mg/day if < 75 kg or 1200 mg/day if ≥ 75 kg

Peginterferon alfa-2a (PEG): 180 µg once weekly

Sofosbuvir and Ribavirin +/- Peginterferon in GT 1-3 ELECTRON Trial (Arms 1-8): Results

ELECTRON: SVR12, by Treatment Regimen

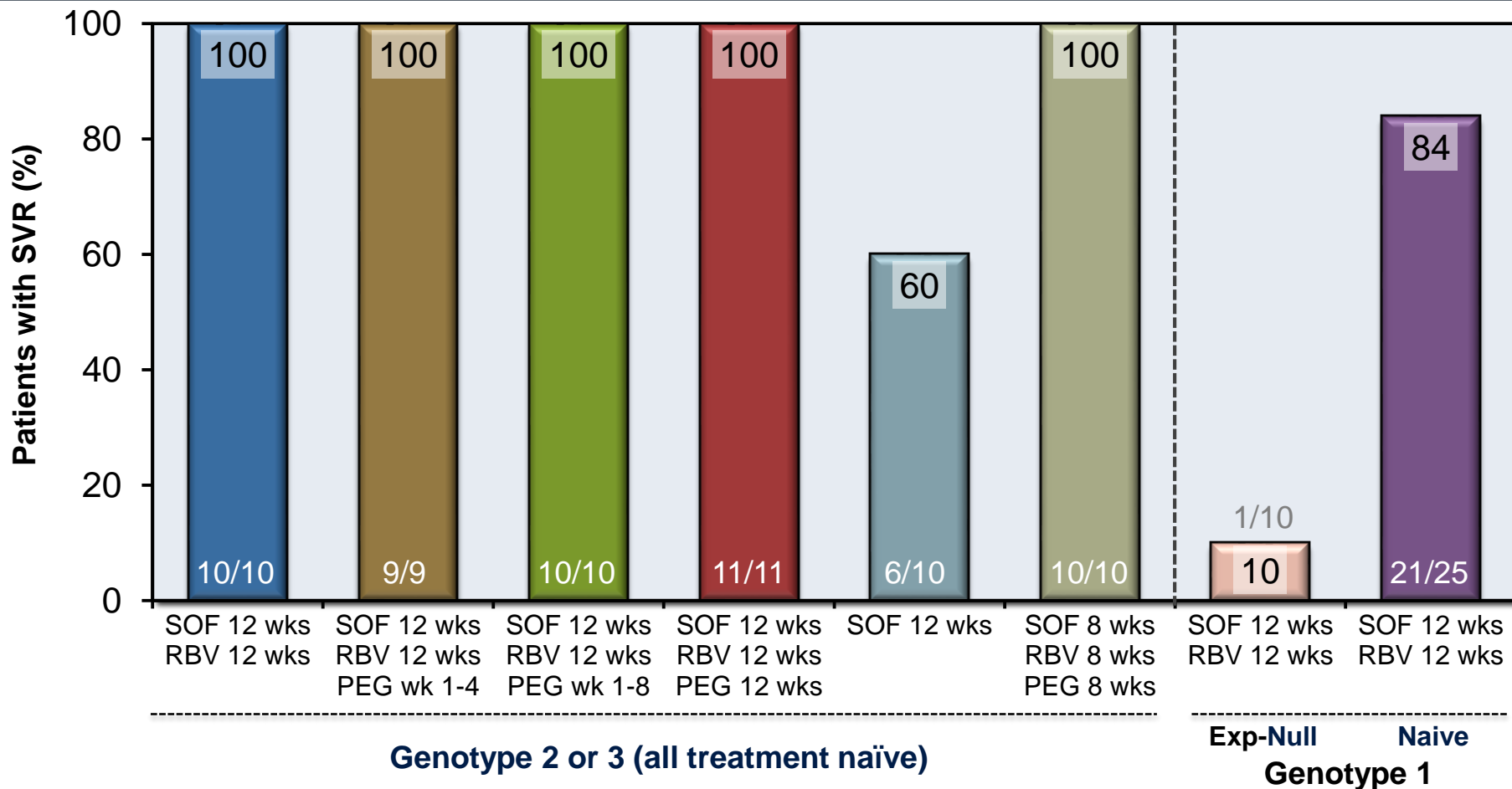

Source: Gane EJ, et al. N Engl J Med. 2013;368:34-44.

Sofosbuvir + RBV in Treatment-Experienced HCV GT 2 or 3 ELECTRON Trial (Arms 1-8): Conclusions

Conclusions: “Sofosbuvir plus ribavirin for 12 weeks may be effective in previously untreated patients with HCV genotype 1, 2, or 3 infection.”

Treatment Naïve and Treatment Experienced

Sofosbuvir in Genotypes 2 or 3 VALENCE Trial

Zeuzem S, et al. N Engl J Med. 2014;370:1993-2001

Sofosbuvir and Ribavirin for HCV GT 2 or 3

VALENCE Trial: Study Features

VALENCE Trial: Features

- **Design:** Randomized, phase 3, using sofosbuvir + ribavirin in treatment naïve or experienced, chronic HCV GT 2 or 3
- **Setting:** Europe
- **Entry Criteria**
 - Chronic HCV Genotype 2 or 3
 - Treatment naïve or treatment experienced
 - Platelet $\geq 50,000$ cells/mm³
- **Patient Characteristics (range in different treatment arms)**
 - N = 419
 - Sex: male (55-62%)
 - Race: white (89-100%)
 - Cirrhosis: (14-23%)
 - IL28B Genotype: non-CC (64-74%)
- **End-Points:** Primary = SVR12; Secondary = safety

Sofosbuvir and Ribavirin for HCV GT 2 or 3

VALENCE: Treatment Arms

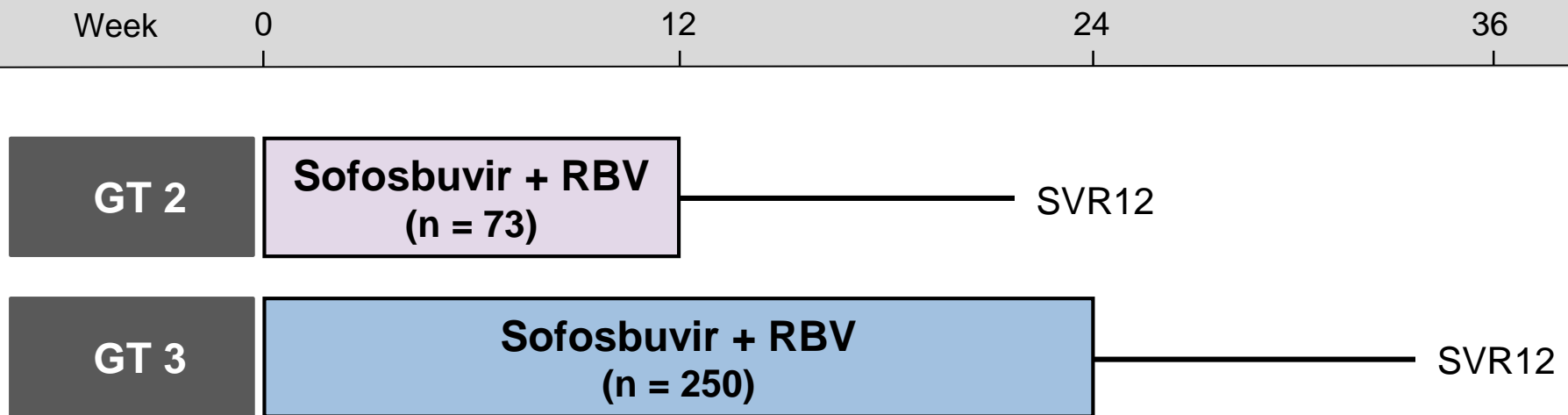

Note: 85 patients enrolled in placebo arm

Original Study Protocol: Placebo versus 12 weeks treatment for GT 2 and 3.

Amended Protocol: GT3 treatment extended from 12 to 24 weeks; Placebo arm offered alternative treatment

Drug Dosing

Sofosbuvir 400 mg once daily

Ribavirin (weight-based and divided bid): 1000 mg/day if < 75 kg or 1200 mg/day if ≥ 75 kg

Sofosbuvir and Ribavirin for HCV GT 2 or 3 VALENCE: Results for Treatment Naïve and Experienced

VALENCE: SVR12 by Genotype

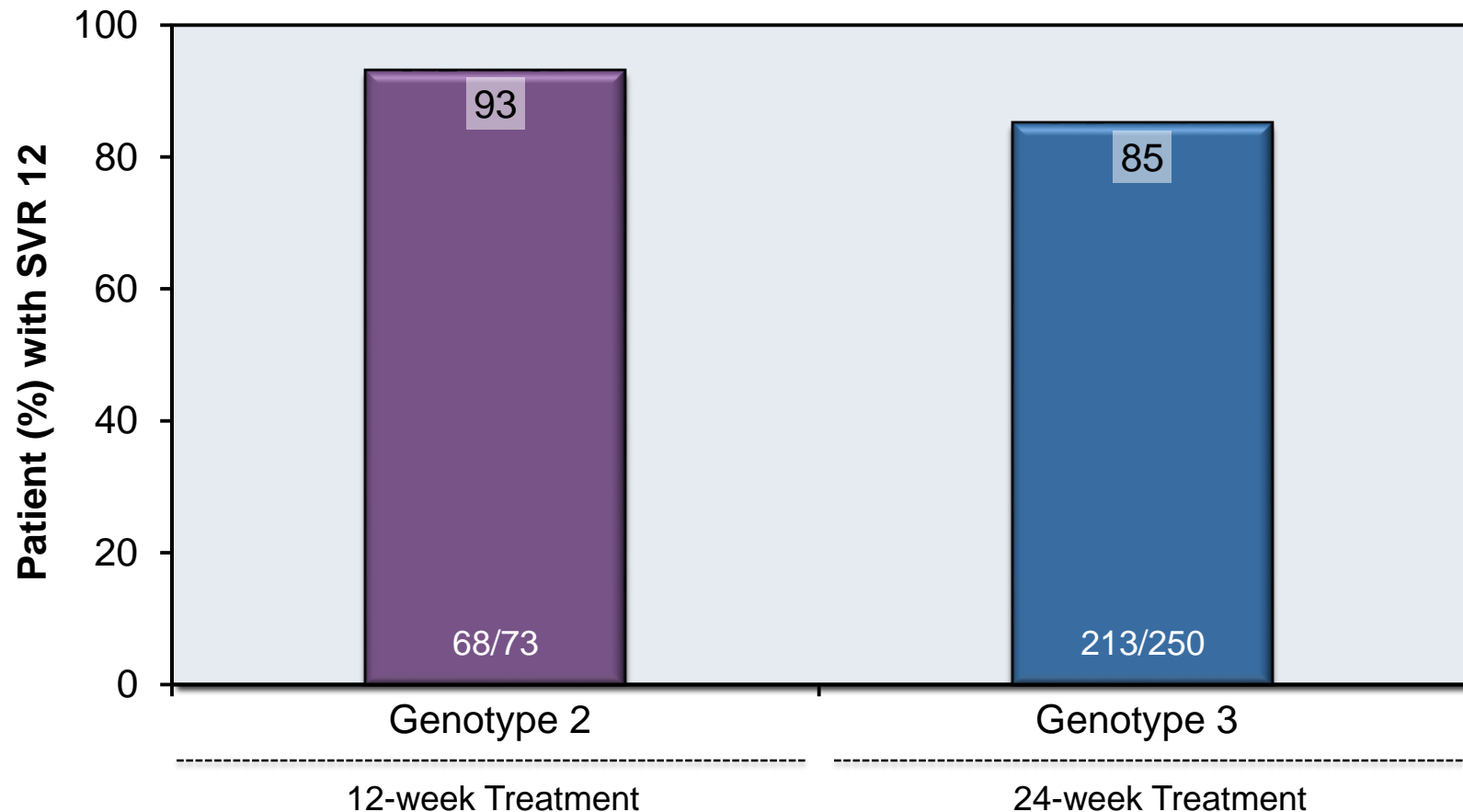

Sofosbuvir and Ribavirin for HCV GT 2 or 3

VALENCE: Results

VALENCE: SVR12 by Genotype and Prior Treatment Experience

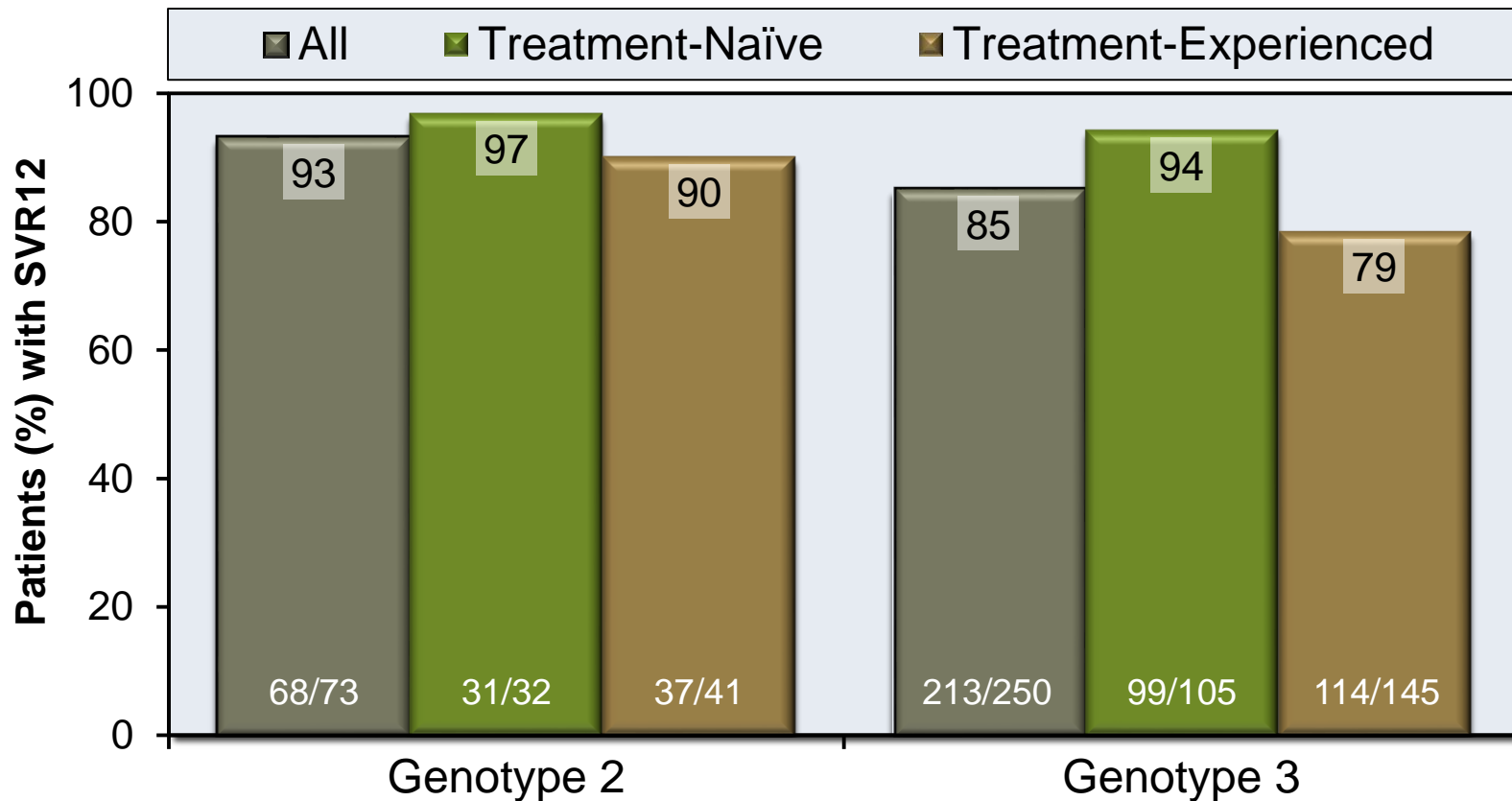

Sofosbuvir and Ribavirin for HCV GT 2 or 3

VALENCE: Results for GT 2

VALENCE: GT 2 SVR12, by Treatment Experience & Liver Disease

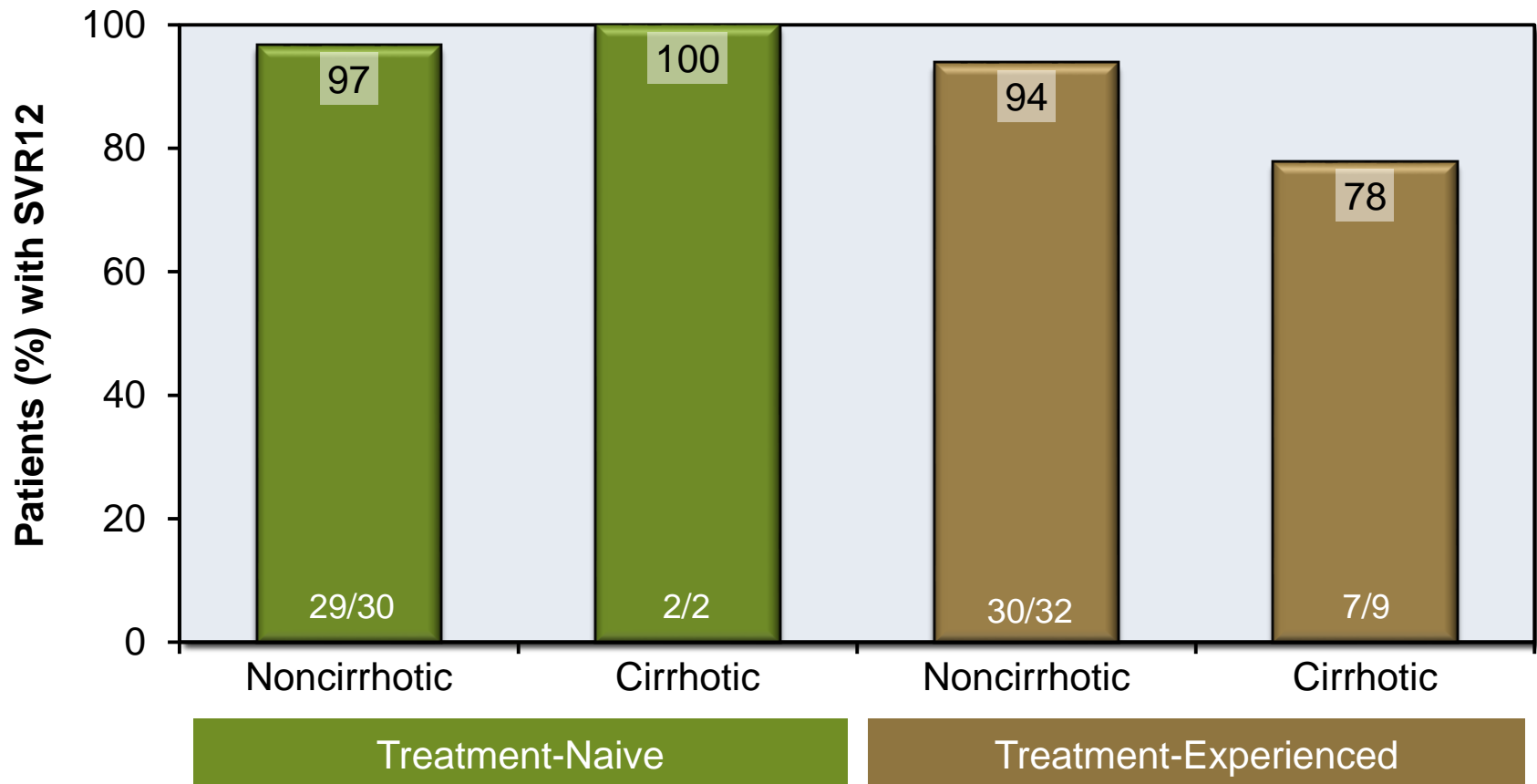

Source: Zeuzem S, et al. N Engl J Med. 2014;370:1993-2001.

Sofosbuvir and Ribavirin for HCV GT 2 or 3

VALENCE: Results for GT 3

VALENCE: GT 3 SVR12, by Treatment Experience & Liver Disease

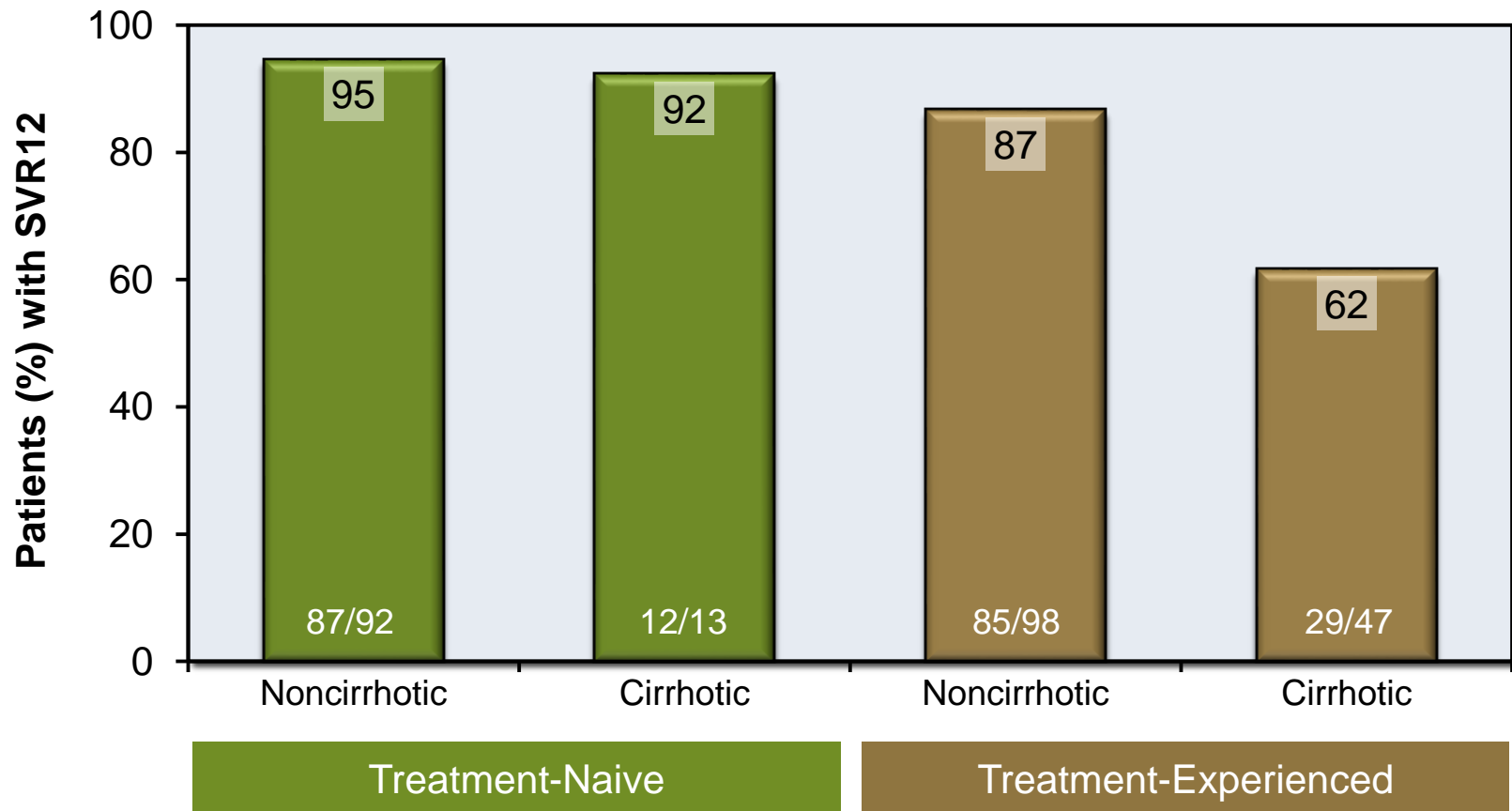

Source: Zeuzem S, et al. N Engl J Med. 2014;370:1993-2001.

Sofosbuvir and Ribavirin for HCV GT 2 or 3

VALENCE: Conclusions

Conclusions: “Therapy with sofosbuvir–ribavirin for 12 weeks in patients with HCV genotype 2 infection and for 24 weeks in patients with HCV genotype 3 infection resulted in high rates of sustained virologic response.”

Treatment Naïve and Treatment Experienced

Sofosbuvir + Peginterferon + Ribavirin in Genotypes 2 or 3 BOSON Trial

Foster GR, et al. 50th EASL. 2015. Abstract L05

Sofosbuvir + Ribavirin +/- Peginterferon for HCV GT 2 or 3

BOSON Trial: Study Features

BOSON Trial: Features

- **Design:** Randomized, multicenter, open-label trial using sofosbuvir and ribavirin with or without peginterferon for treatment naive or experienced patients with chronic HCV genotype 2 or 3
- **Setting:** International at 80 sites
- **Entry Criteria**
 - Chronic HCV Genotype 2, treatment experienced, with cirrhosis
 - Chronic HCV Genotype 3, +/- treatment experienced, +/- cirrhosis
 - Platelet $\geq 60,000$ cells/mm³
- **End-Points:** SVR12; safety

Sofosbuvir + Ribavirin +/- Peginterferon for HCV GT 2 or 3

BOSON: Treatment Arms

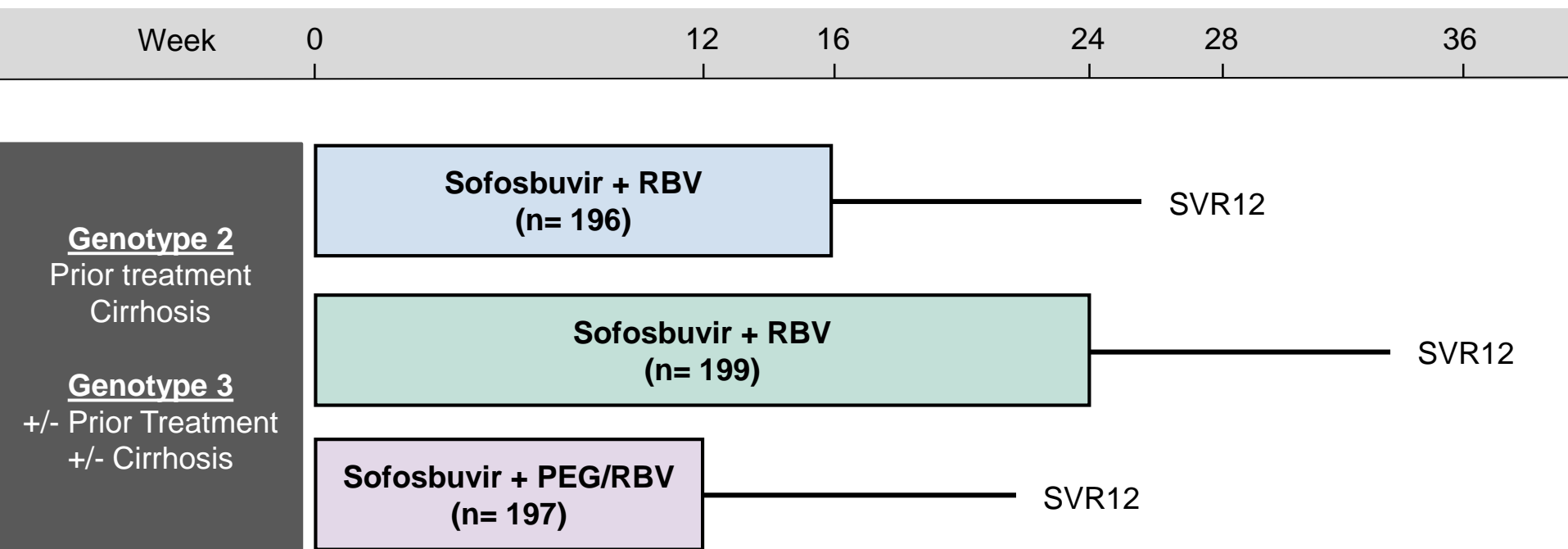

Drug Dosing

Sofosbuvir 400 mg once daily

Ribavirin (weight-based and divided bid): 1000 mg/day if < 75 kg or 1200 mg/day if ≥ 75 kg

Peginterferon alfa-2a: 180 ug/week

Sofosbuvir + Ribavirin +/- Peginterferon for HCV GT 2 or 3

BOSON: Results

SVR12 by Regimen and Genotype

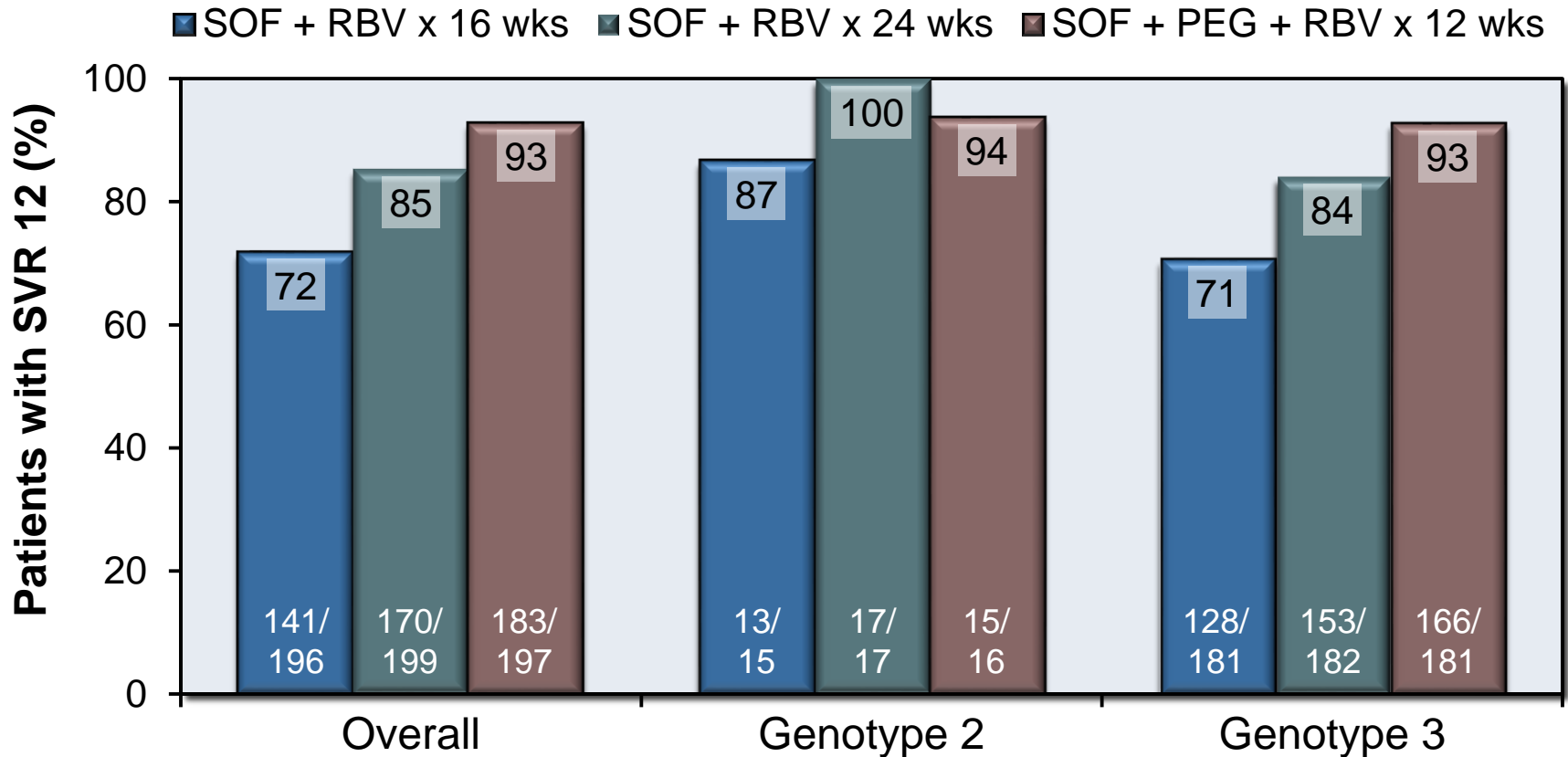

Sofosbuvir + Ribavirin +/- Peginterferon for HCV GT 2 or 3

BOSON: Results

Genotype 3: SVR12 by Regimen

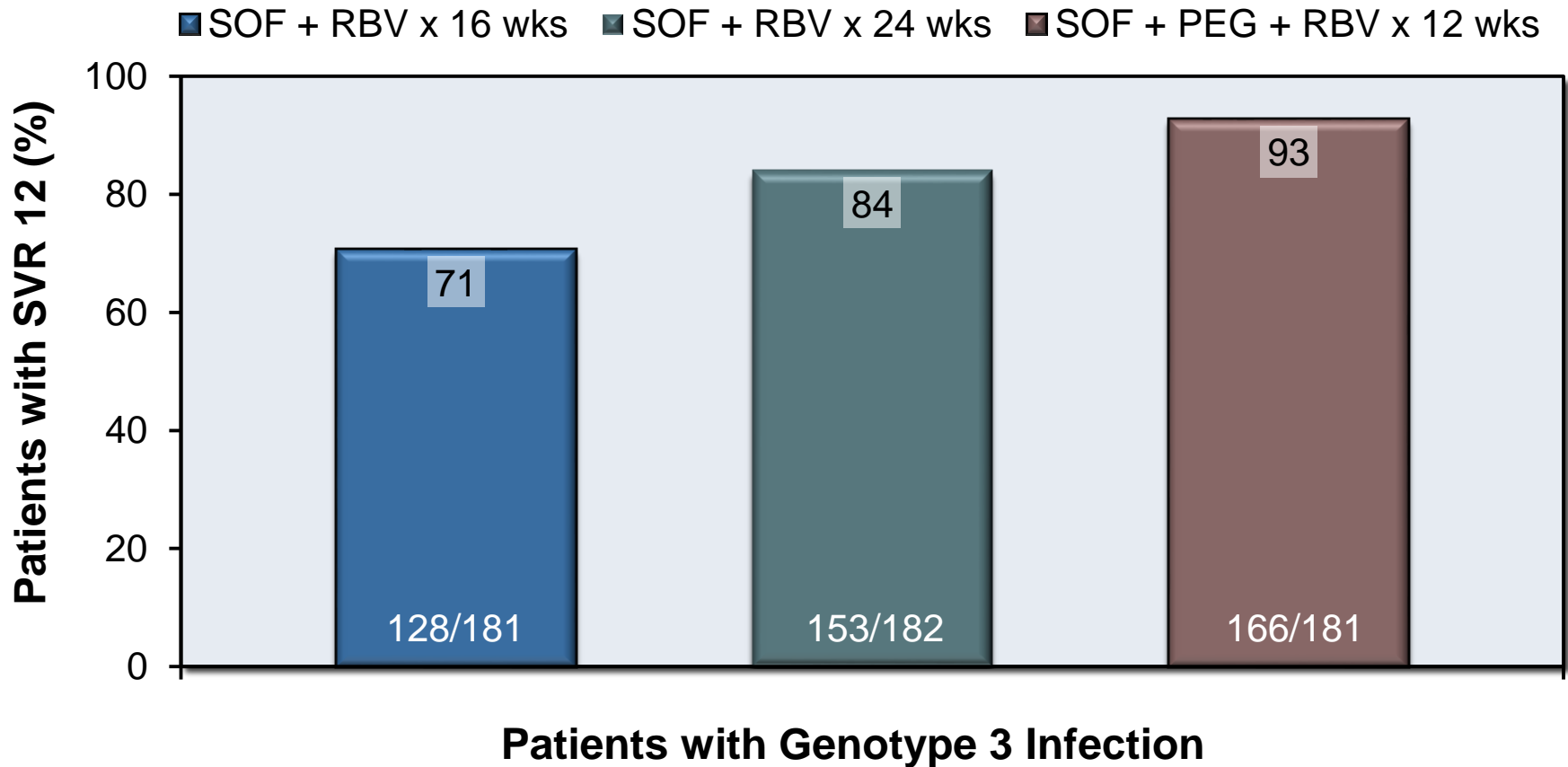

Sofosbuvir + Ribavirin +/- Peginterferon for HCV GT 2 or 3

BOSON: Results

Genotype 3: SVR12 by Regimen and Cirrhosis Status

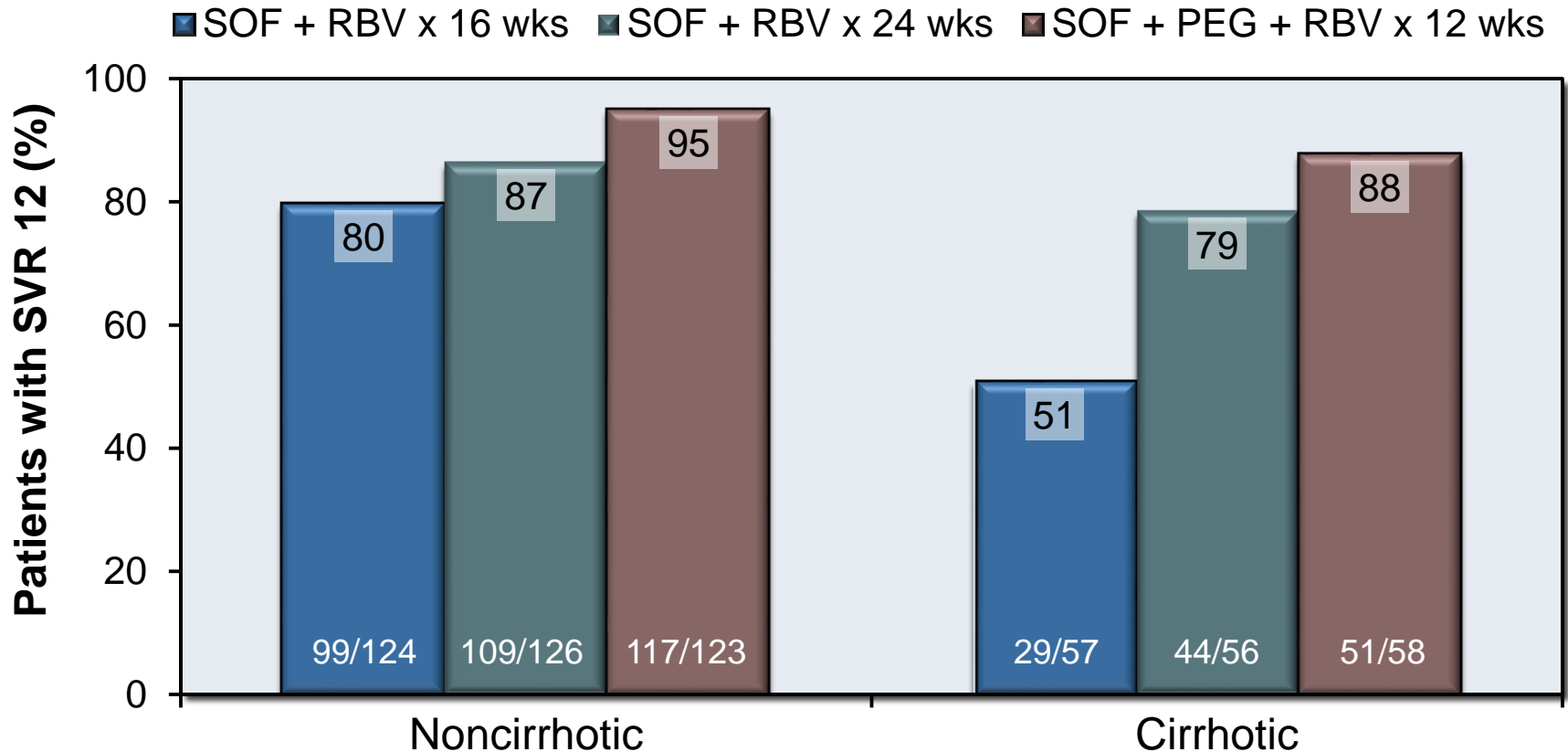

Sofosbuvir + Ribavirin +/- Peginterferon for HCV GT 2 or 3 BOSON: Results

Genotype 3: SVR12 by Regimen and Treatment History

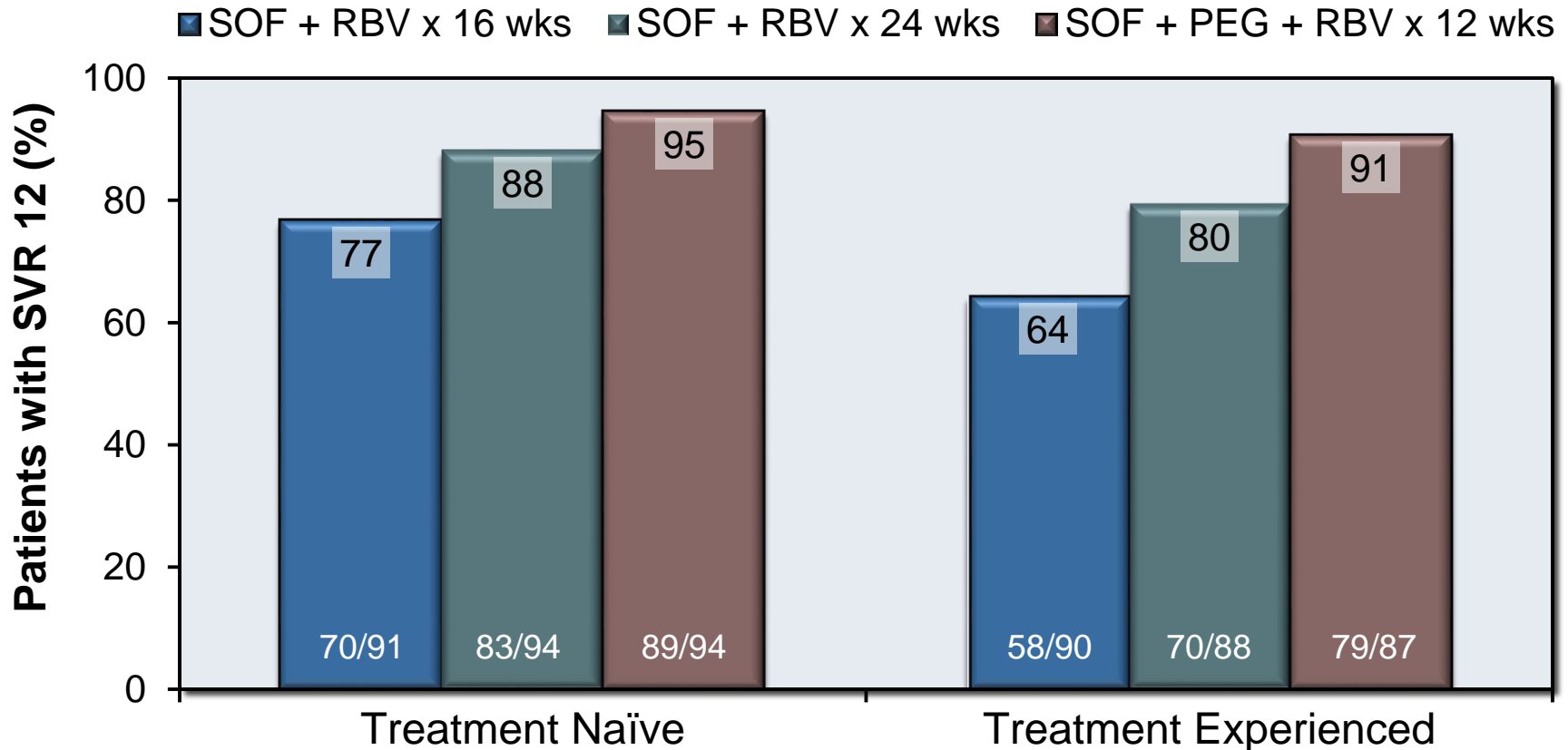

Treatment Naïve and Treatment Experienced

Sofosbuvir + Ribavirin in HCV GT 4 Egyptian Ancestry Trial

Ruane PJ, et al. J Hepatol. 2015;62:1040-6.

Sofosbuvir and Ribavirin in HCV Genotype 4 Egyptian Ancestry Trial: Study Features

Egyptian Ancestry Genotype 4 Trial: Features

- **Design:** Randomized, open-label, phase 2 study of sofosbuvir + ribavirin in treatment-naïve and treatment-experienced patients with HCV GT 4
- **Setting:** single study center in United States
- **Entry Criteria**
 - HCV Genotype 4
 - Born in Egypt to two parents of Egyptian ancestry
 - Age 18 or older
 - Treatment naïve or treatment experienced
 - HCV RNA $\geq 10,000$ log IU/ml
 - Not co-infected with HIV
 - Patients with compensated cirrhosis allowed
 - Cirrhosis defined as: Fibrotest score > 0.75 plus APRI > 2 during screening
- **Primary End-Points:** Efficacy (SVR12) and safety

Sofosbuvir and Ribavirin in HCV Genotype 4 Egyptian Ancestry Trial: Baseline Characteristics

Chronic HCV GT4: Treatment with Sofosbuvir + Ribavirin		
Baseline Characteristic	SOF + RBV x 12 Weeks (n=31)	SOF + RBV x 24 Weeks (n=29)
Mean Age, y (range)	53 (26-62)	55 (27-75)
Male, n %	22 (71)	19 (66)
Mean BMI kg/m ² (range)	28.6 (21.3-34.5)	30.2 (19.9-42.3)
HCV Genotype		
4a	28 (90)	20 (69)
4II	1 (3)	1 (3)
4m	0	1 (3)
4n	1 (3)	2 (7)
4o	1 (3)	5 (17)
Cirrhosis, n %	7 (23)	7 (24)
<i>IL28B</i> CC genotype, n (%)	4 (13)	6 (21)
Treatment naïve, n (%)	14 (45)	14 (48)
HCV RNA, mean baseline log ₁₀ IU/ml	6.0	6.0

Sofosbuvir and Ribavirin in HCV Genotype 4 Egyptian Ancestry Trial: Design

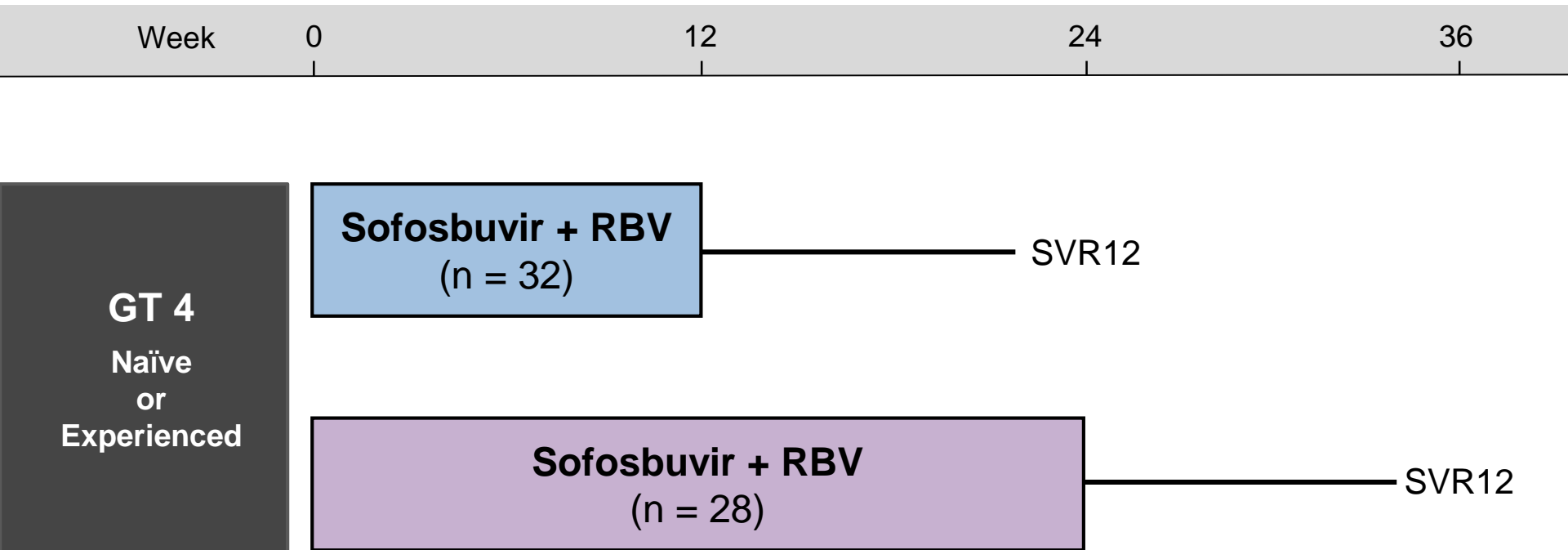

Drug Dosing

Sofosbuvir: 400 mg once daily

Weight-Based Ribavirin (in 2 divided doses): 1000 mg/day if < 75 kg or 1200 mg/day if ≥ 75 kg

Sofosbuvir and Ribavirin in HCV Genotype 4 Egyptian Ancestry Trial: Results

SVR12 by Regimen Duration and Treatment Experience

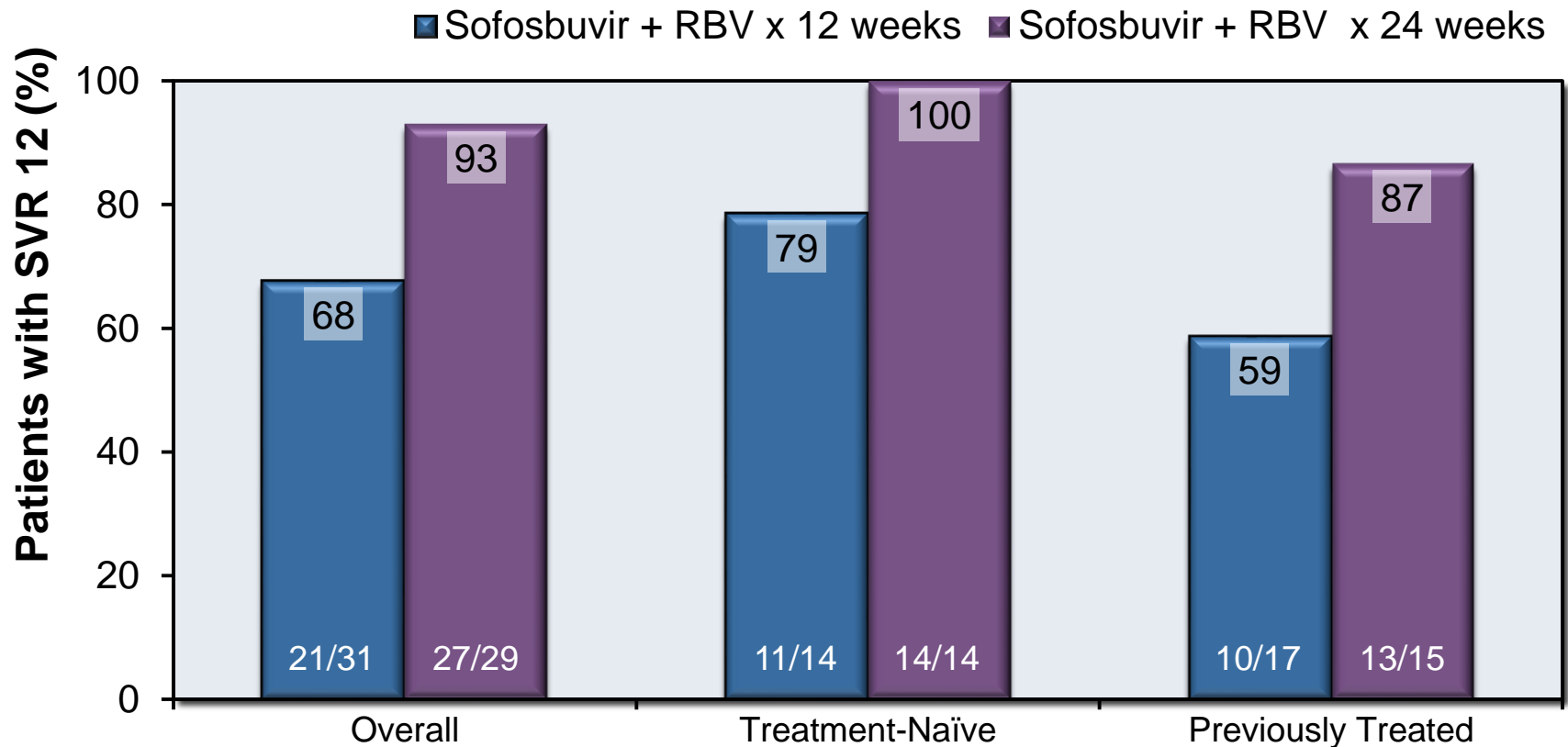

Sofosbuvir and Ribavirin in HCV Genotype 4 Egyptian Ancestry Trial: Conclusions

Conclusions: “The findings from the present study suggest that 24weeks of sofosbuvir plus ribavirin is an efficacious and well tolerated treatment in patients with HCV genotype 4 infection.”

Sofosbuvir in Patients with HCV-HIV Coinfection

Sofosbuvir in HCV-HIV Coinfection & HCV GT 1,2,3 PHOTON-1 Trial

Sulkowski MS, et al. JAMA. 2014;312:353-61.

Sofosbuvir and Ribavirin for HCV-HIV Coinfection

PHOTON-1 Trial: Study Features

PHOTON-1 Trial: Features

- **Design:** Open-label, nonrandomized, uncontrolled, phase 3 trial using sofosbuvir + ribavirin in HCV-HIV coinfection and HCV GT 1, 2, or 3
- **Setting:** 34 treatment centers in United States and Puerto Rico
- **Entry Criteria**
 - HIV coinfection; HCV Genotype 1, 2, or 3
 - Treatment naïve (GT 1,2,3) or treatment experienced (GT 2,3)
 - On antiretroviral therapy with HIV RNA \leq 50 copies/ml and CD4 \geq 200 or not on antiretroviral therapy and CD4 \geq 500
 - Compensated cirrhosis permitted (<20% total patients)
- **Patient Characteristics**
 - N = 223 HCV-HIV coinfecting patients
 - On ARV Rx: GT1 (98%); GT 2/3 naïve (90%); GT 2/3 experienced (95%)
- **Primary End-Points**
 - Efficacy (SVR12), safety, and impact on HIV

Sofosbuvir and Ribavirin for HCV-HIV Coinfection

PHOTON-1 Trial: Participants

Baseline Characteristics	Treatment Naive		Treatment Experienced
	GT 1 (n=114)	GT 2 or 3 (n=68)	GT 2 or 3 (n=41)
Age, mean (range)	48 (25-70)	49 (24-71)	54 (34-68)
Male, %	82%	81%	90%
Black, %	32%	12%	17%
IL28B CC genotype, %	27%	37%	49%
Cirrhosis, %	4%	10%	24%
On ART [§] , %	98%	90%	95%
CD4 count, cells/mm ³ , median	581	562	579

[§]Tenofovir-emtricitabine plus [efavirenz, r-atazanavir, r-darunavir, raltegravir, rilpivirine, or other]

Sofosbuvir and Ribavirin for HCV-HIV Coinfection

PHOTON-1 Trial: Treatment Arms

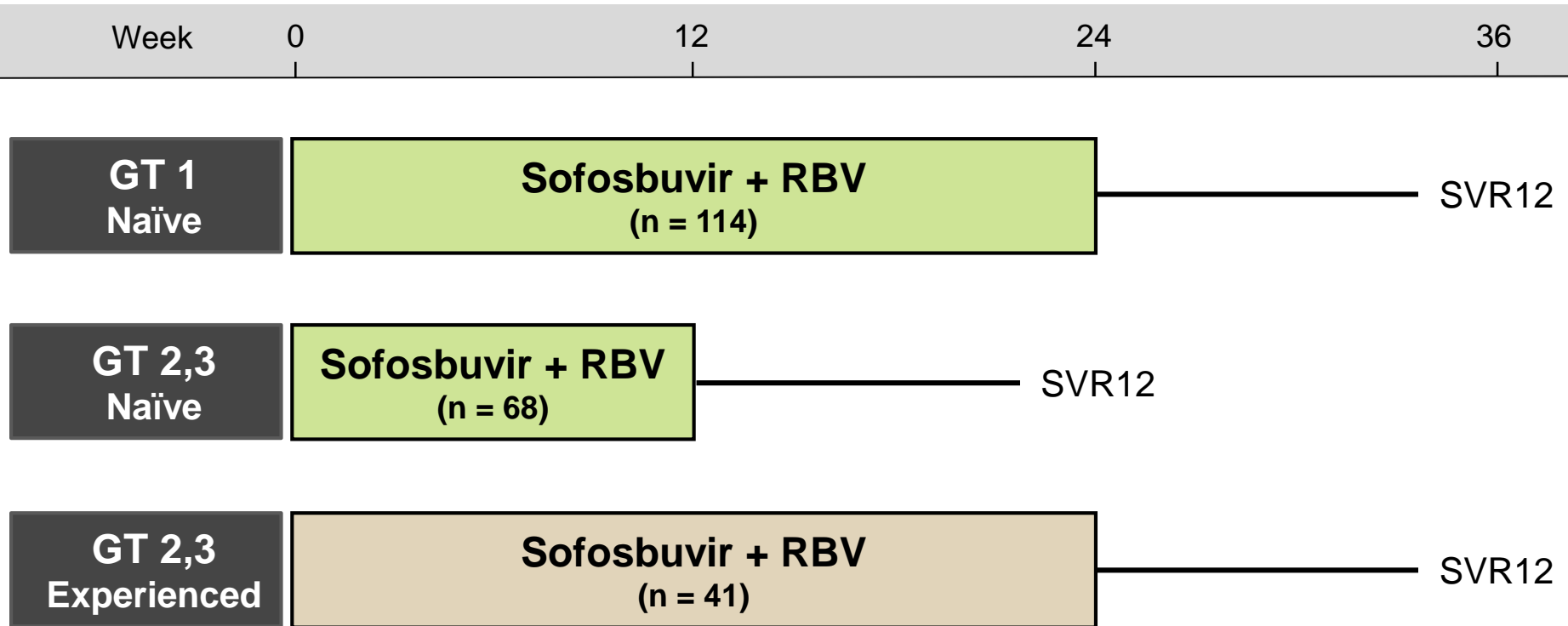

Drug Dosing

Sofosbuvir: 400 mg once daily

Ribavirin (weight-based and divided bid): 1000 mg/day if < 75 kg or 1200 mg/day if ≥ 75 kg

Sofosbuvir and Ribavirin for HCV-HIV Coinfection PHOTON-1 Trial: Results

PHOTON-1: SVR12 with Sofosbuvir + RBV x 12-24 weeks

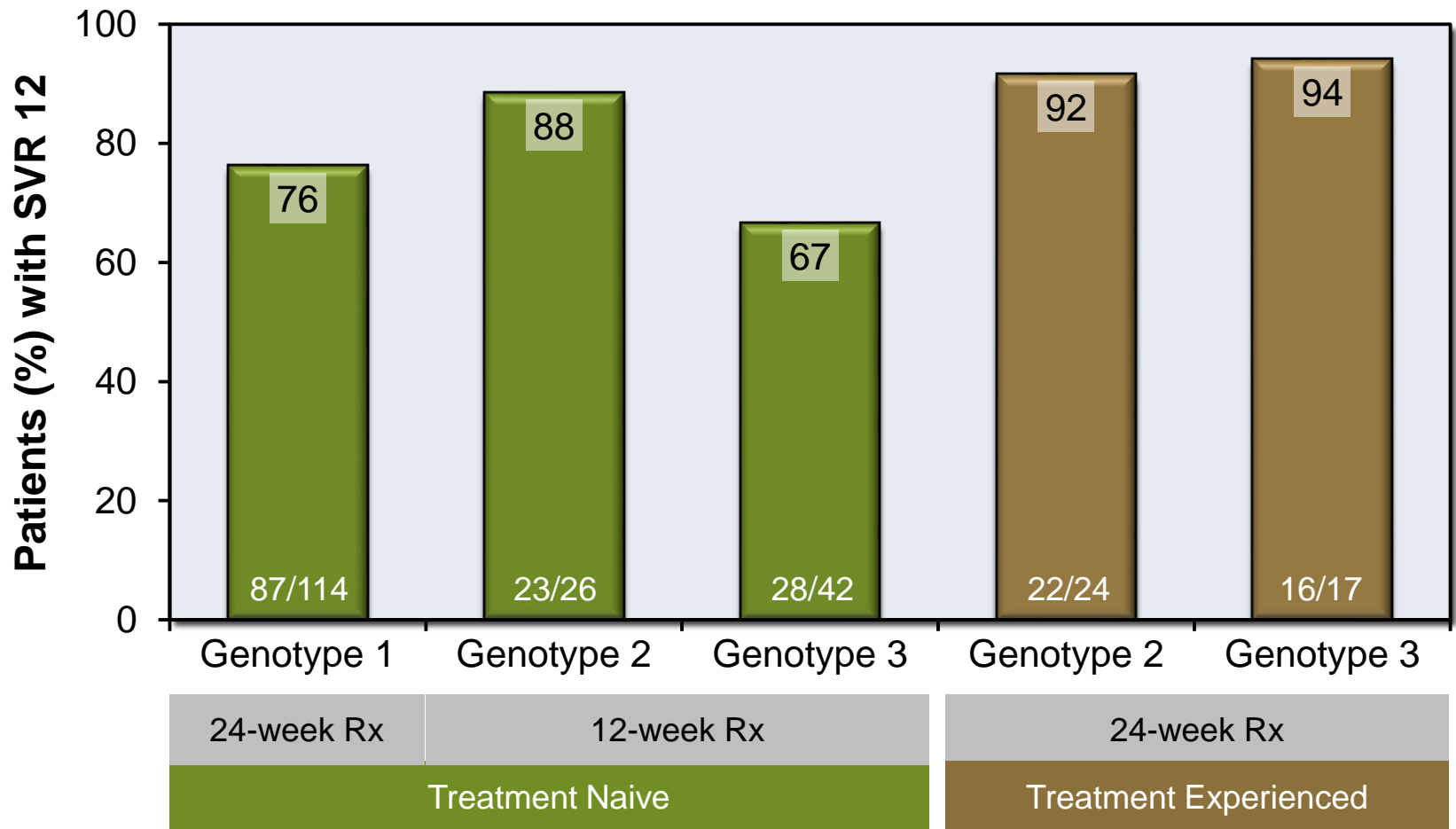

Source: Sulkowski MS, et al. JAMA. 2014;312:353-61.

Sofosbuvir and Ribavirin for HCV-HIV Coinfection PHOTON-1 Trial: Conclusions

Conclusions and Relevance: “In this open-label, nonrandomized, uncontrolled study, patients with HIV who were coinfecting with HCV genotype 1, 2, or 3 who received the oral, interferon-free combination of sofosbuvir and ribavirin for 12 or 24 weeks had high rates of SVR12. Further studies of this oral regimen in diverse populations of coinfecting patients are warranted.”

Sofosbuvir + Ribavirin in HCV-HIV Coinfection: HCV GT 1,2,3,4 PHOTON-2 Trial

Molina JM, et al. Lancet. 2015;385:1098-106.

Sofosbuvir plus Ribavirin for HCV-HIV Coinfection

PHOTON-2 Trial: Study Features

PHOTON-2 Trial: Features

- **Design:** Open-label, nonrandomized, uncontrolled, phase 3 trial using sofosbuvir + ribavirin for HCV GT 1, 2, 3, or 4 in persons coinfecting with HIV
- **Setting:** 45 clinics in Europe
- **Entry Criteria**
 - HIV coinfection; HCV Genotype 1, 2, 3, or 4
 - Age 18 or older
 - HCV treatment naïve (GT 1-4) or treatment experienced (GT 2 or 3)
 - On HIV ARV Rx with HIV RNA \leq 50 copies/ml and CD4 $>$ 200 cells/mm³
 - Not on HIV ARV Rx and CD4 $>$ 500 cells/mm³
 - ARV regimen allowed: tenofovir-emtricitabine plus either ritonavir boosted atazanavir or darunavir, efavirenz, rilpivirine, or raltegravir
 - Compensated cirrhosis permitted (up to 20% of subjects); no platelet cutoff
- **Primary End-Points**
 - Efficacy (SVR12), safety, and impact on HIV

Sofosbuvir plus Ribavirin for HCV-HIV Coinfection

PHOTON-2 Trial: Treatment Arms

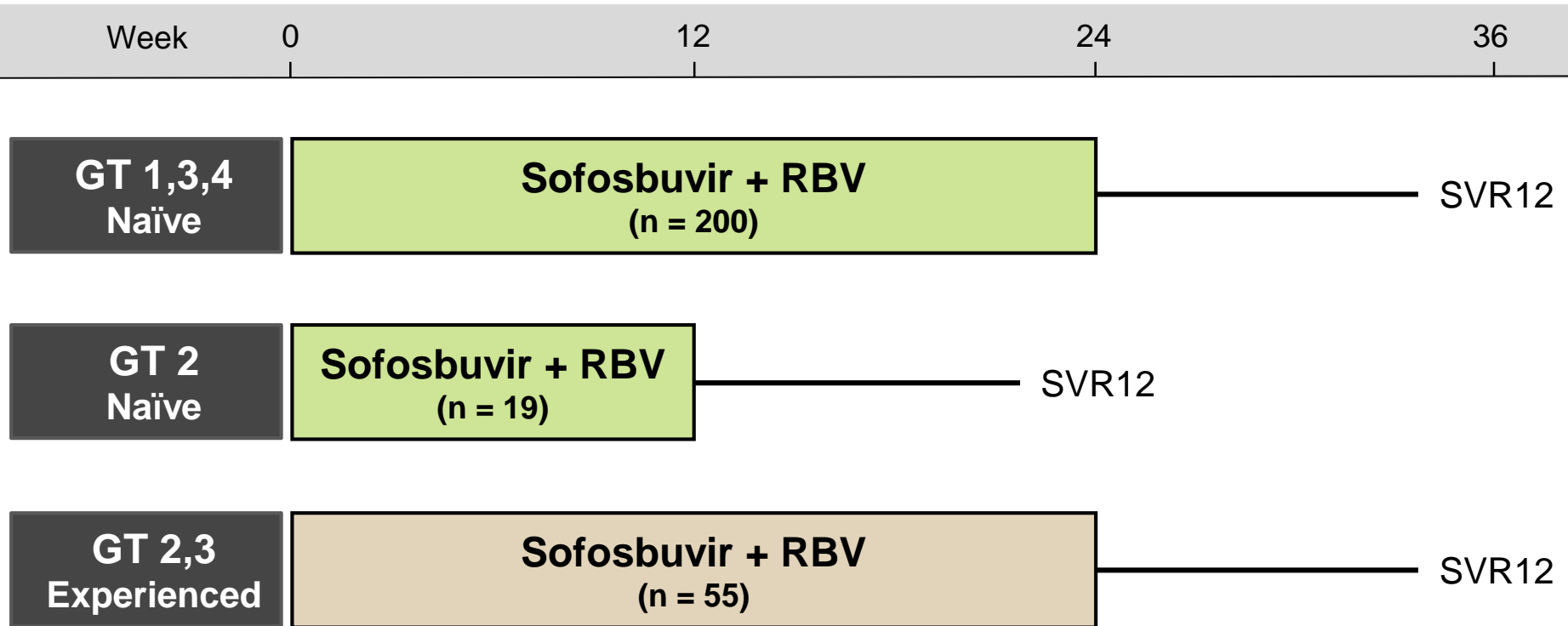

Drug Dosing

Sofosbuvir: 400 mg once daily

Ribavirin (weight-based and divided bid): 1000 mg/day if < 75 kg or 1200 mg/day if ≥ 75 kg

Sofosbuvir plus Ribavirin for HCV-HIV Coinfection PHOTON-2 Trial: Results

PHOTON-2: SVR12 with Sofosbuvir + RBV x 12-24 weeks

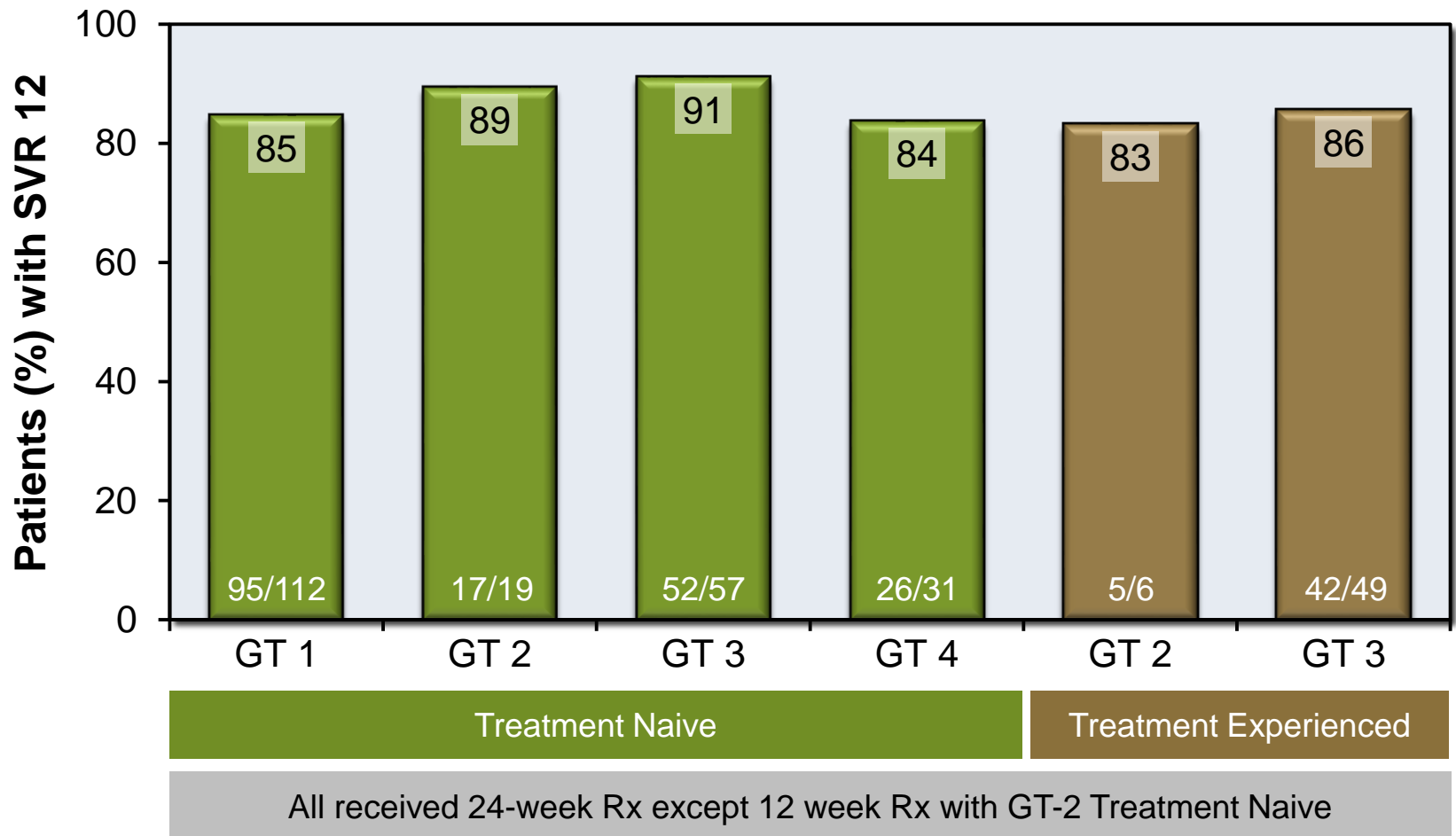

Sofosbuvir plus Ribavirin for HCV-HIV Coinfection PHOTON-2 Trial: Results

PHOTON-2: SVR12 with Sofosbuvir + RBV, by Genotype

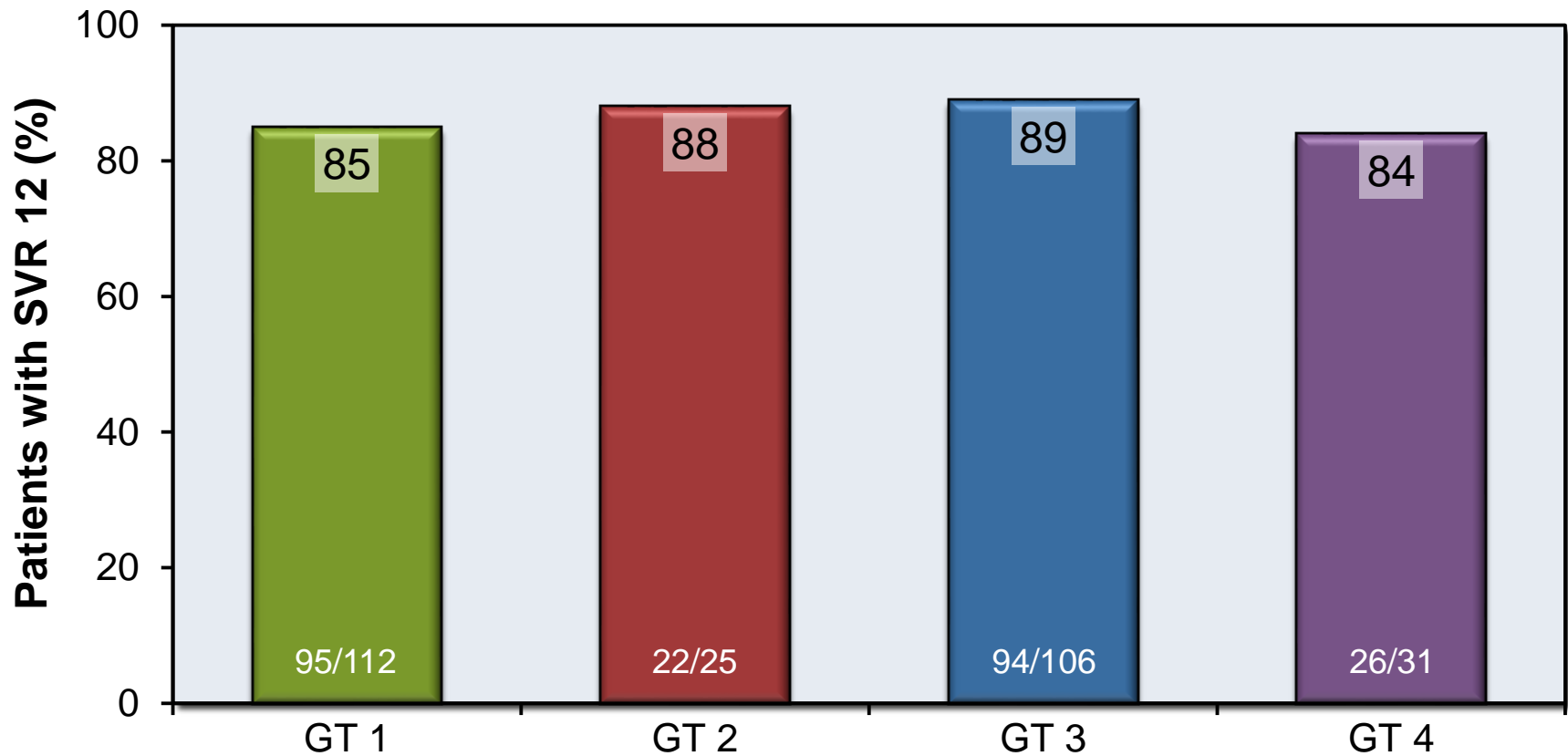

Sofosbuvir and Ribavirin for HCV-HIV Coinfection PHOTON-2 Trial: Interpretation

Interpretation: “Sofosbuvir and ribavirin provided high rates of sustained virological response after 12 weeks of treatment in treatment-naive and treatment-experienced patients co-infected with HIV and HCV genotypes 1–4. The characteristics of this interferon-free combination regimen make sofosbuvir plus ribavirin a useful treatment option for this patient population.”

Sofosbuvir + Peginterferon+ Ribavirin in HCV-HIV GT 1-4

Rodriguez-Torres M, et al. J Acquir Immune Defic Syndr. 2015;68:543-9.

Sofosbuvir + PEG + RBV for HCV-HIV Coinfection

Study Features

Sofosbuvir + PEG + RBV for HCV GT 1-6 and HIV Coinfection: Features

- **Design:** Open-label, single-arm, phase 2 trial of sofosbuvir plus peginterferon alfa-2a plus ribavirin in HCV GT 1-6 with HIV coinfection
- **Setting:** single site in Puerto Rico
- **Entry Criteria**
 - Chronic HIV coinfection; HCV genotype 1-6
 - Age \geq 21
 - HCV treatment naïve
 - On antiretroviral therapy for at least 8 weeks
 - CD4 count greater than 200 cells/mm³
 - No cirrhosis
- **Patient Characteristics**
 - N = 23 HCV-HIV coinfecting patients
 - GT1 (n=19); GT2 (n=1); GT3 (n=2); GT4 (n=1)
- **Primary End-Points**
 - Efficacy (SVR12), safety/tolerability, and impact on HIV

Sofosbuvir + PEG + RBV for HCV-HIV Coinfection

Demographics

Sofosbuvir + PEG + RBV for HCV GT 1-4 and HIV Coinfection	
Baseline Characteristics	Patients (n=23)
Age, mean (range)	47 (29-59)
Male, n (%)	18 (78.3)
Mean BMI (range)	26.3 (18.0-46.4)
Race, n (%)	
White	15 (65.2)
Black/African American	8 (34.8)
HCV Genotype, n (%)	
1a	15 (65.2)
1b	4 (17.4)
2b	1 (4.3)
3a	2 (8.7)
4	1 (4.3)
Mean CD4 count, cells/mm ³	562

Sofosbuvir + PEG + RBV for HCV-HIV Coinfection P7977-1910 Trial: Antiretroviral Regimens

Sofosbuvir + PEG + RBV for HCV GT 1-4 and HIV Coinfection	
Antiretroviral Agent	Antiretroviral Treated (n = 23)
Tenofovir-emtricitabine	23 (100%)
Efavirenz	7 (30%)
Rilpivirine	1 (4%)
Atazanavir/ritonavir	5 (22%)
Darunavir/ritonavir	4 (17%)
Raltegravir	6 (26%)

Sofosbuvir + PEG + RBV for HCV-HIV Coinfection

Week

0

12

24

**GT 1-4
Naïve**

**Sofosbuvir + Peginterferon
+ Ribavirin (n = 23)**

SVR12

Drug Dosing

Sofosbuvir: 400 mg once daily

Peginterferon alfa-2a 180 mcg per week

Ribavirin (weight-based and divided bid): 1000 mg/day if < 75 kg or 1200 mg/day if ≥ 75 kg

Sofosbuvir + PEG + RBV for HCV-HIV Coinfection Results

SVR12, by Genotype

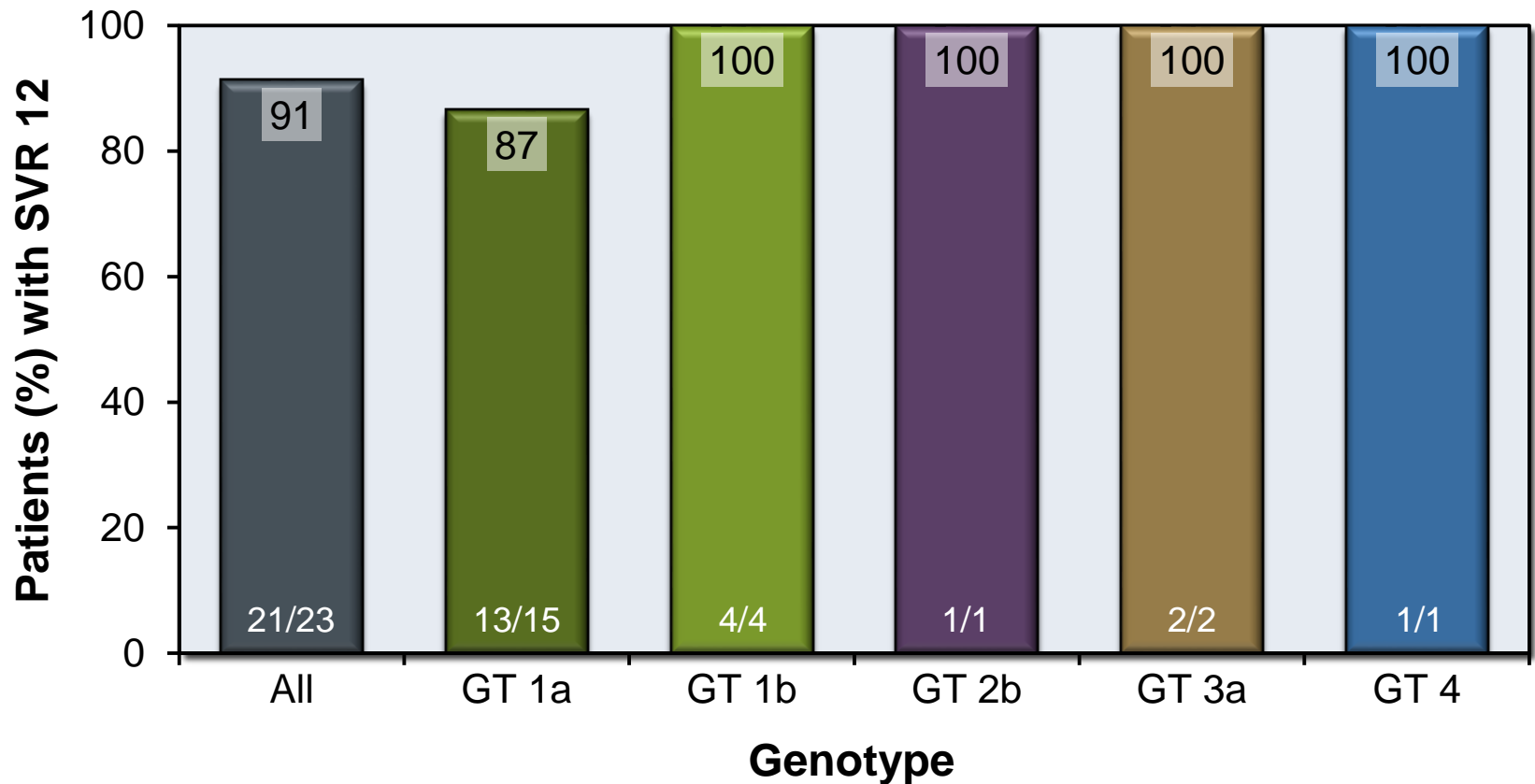

Sofosbuvir + PEG + RBV for HCV-HIV Coinfection Results

SVR12, by Antiretroviral Regimen

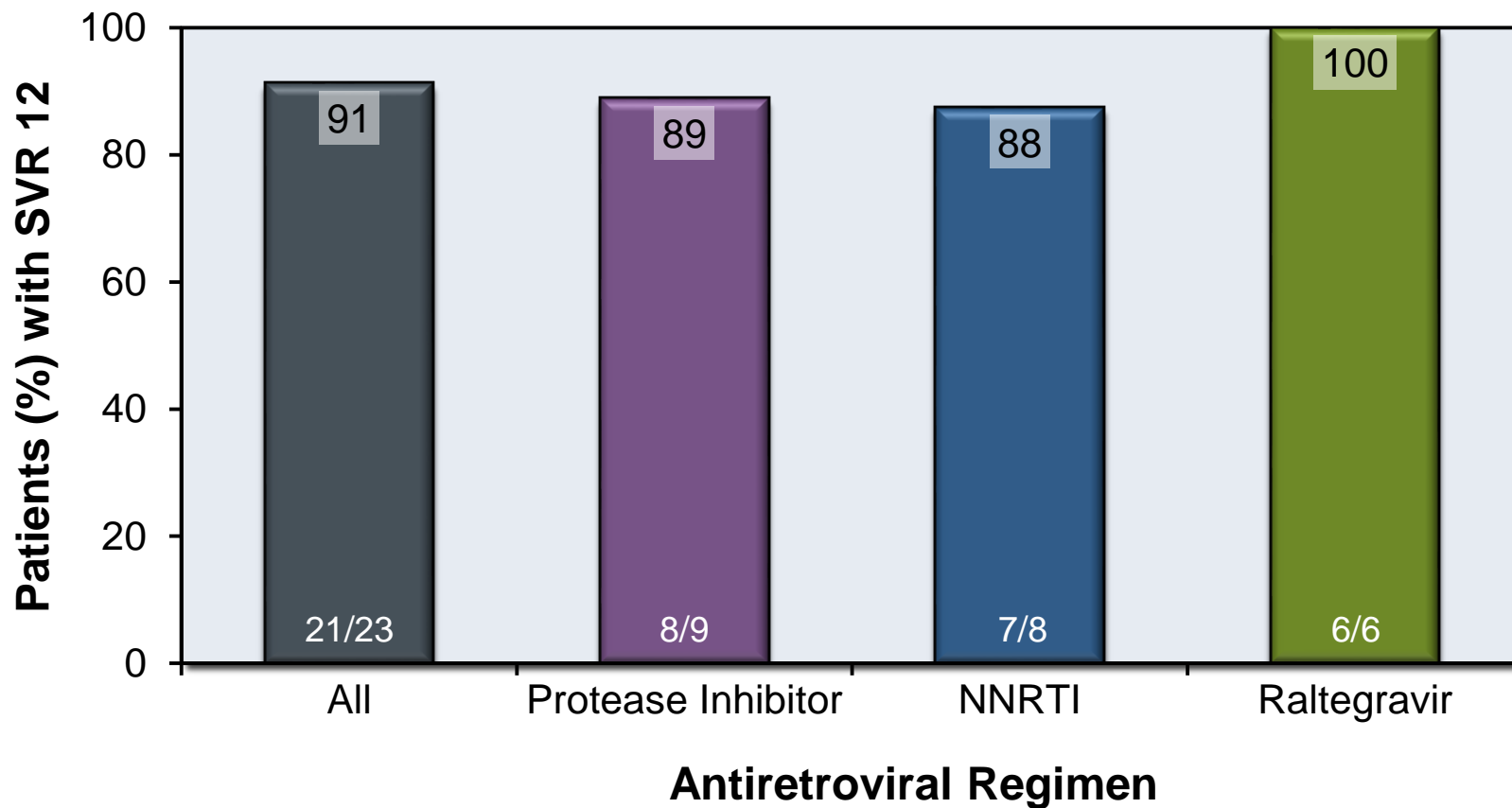

Sofosbuvir + PEG + RBV for HCV-HIV Coinfection

Results: Interpretation

Interpretation: “Sofosbuvir may be coadministered safely with many commonly used antiretrovirals. The addition of sofosbuvir to peginterferon–ribavirin was highly effective as assessed by SVR in HCV/HIV-coinfected patients.”

Sofosbuvir in Patients with Renal Disease

Sofosbuvir-Containing Regimens including Patients with Renal Disease HCV-TARGET (Renal Disease)

Saxena V, et al. 50th EASL. 2015; Abstract LP08.

Sofosbuvir-Containing Regimens including Patients with Renal Disease

HCV-TARGET Trial: Study Features

HCV-Target and Patients with Renal Disease: Features

- **Design:** Longitudinal, cohort study with sofosbuvir-containing regimens, including patients with renal disease
- **Setting:** 56 centers in US, Germany, and Canada
- **Entry Criteria**
 - Chronic HCV treated with sofosbuvir-containing regimen
 - HCV genotype 1-6
 - Age 18 or older
 - Treatment naïve and treatment experienced
 - Includes patients with baseline renal insufficiency
 - Includes patients with cirrhosis
- **Primary End-Points**
 - Efficacy (SVR12), safety

Sofosbuvir-Containing Regimens including Patients with Renal Disease

HCV-TARGET Trial: Baseline Characteristics

Baseline Characteristic	eGFR ≤ 30 (n = 19)	eGFR 31-45 (n = 63)	eGFR 46-60 (n = 168)	eGFR > 60 (n= 1643)
Female, n (%)	14 (74)	29 (46)	77 (46)	570 (35)
Age ≥ 65, n (%)	5 (26)	18 (29)	55 (33)	292 (18)
White, n (%)	15 (79)	45 (71)	140 (83)	1313 (80)
Cirrhosis, n (%)	8 (42)	43 (68)	95 (57)	844 (51)
History of decompensation, n (%)	6 (32)	30 (48)	55 (33)	380 (23)
MELD ≥ 10, n (%)	5 (26)	26 (41)	33 (20)	227 (14)
Liver transplant	7 (37)	34 (54)	57 (34)	136 (8)
Kidney transplant	3 (16)	5 (8)	9 (5)	12 (1)
HCC, n (%)	1 (5)	16 (25)	34 (20)	160 (10)
Mean total bilirubin, mg/dL (range)	2.1 (0.2-21)	1.6 (0.2-22)	1.0 (0.1-8.0)	1 (0.1-15)
Mean albumin, g/dL (range)	3.6 (2.5-5.0)	3.7 (1.8-5.0)	3.8 (2.0-5)	3.9 (1.2-5)
Mean platelets x 10 ³ /μL (range)	145 (38-267)	142 (37-306)	162 (42-595)	155 (14-567)
Mean INR (range)	1.1 (0.9-1.4)	1.2 (0.9-4.0)	1.2 (0.9-3.0)	1.1 (0.7-4.0)

Source: Saxena V, et al. 50th EASL. 2015; Abstract LP08.

Sofosbuvir-Containing Regimens in Patients with Renal Disease HCV -TARGET

HCV TARGET: SVR12, by Baseline eGFR

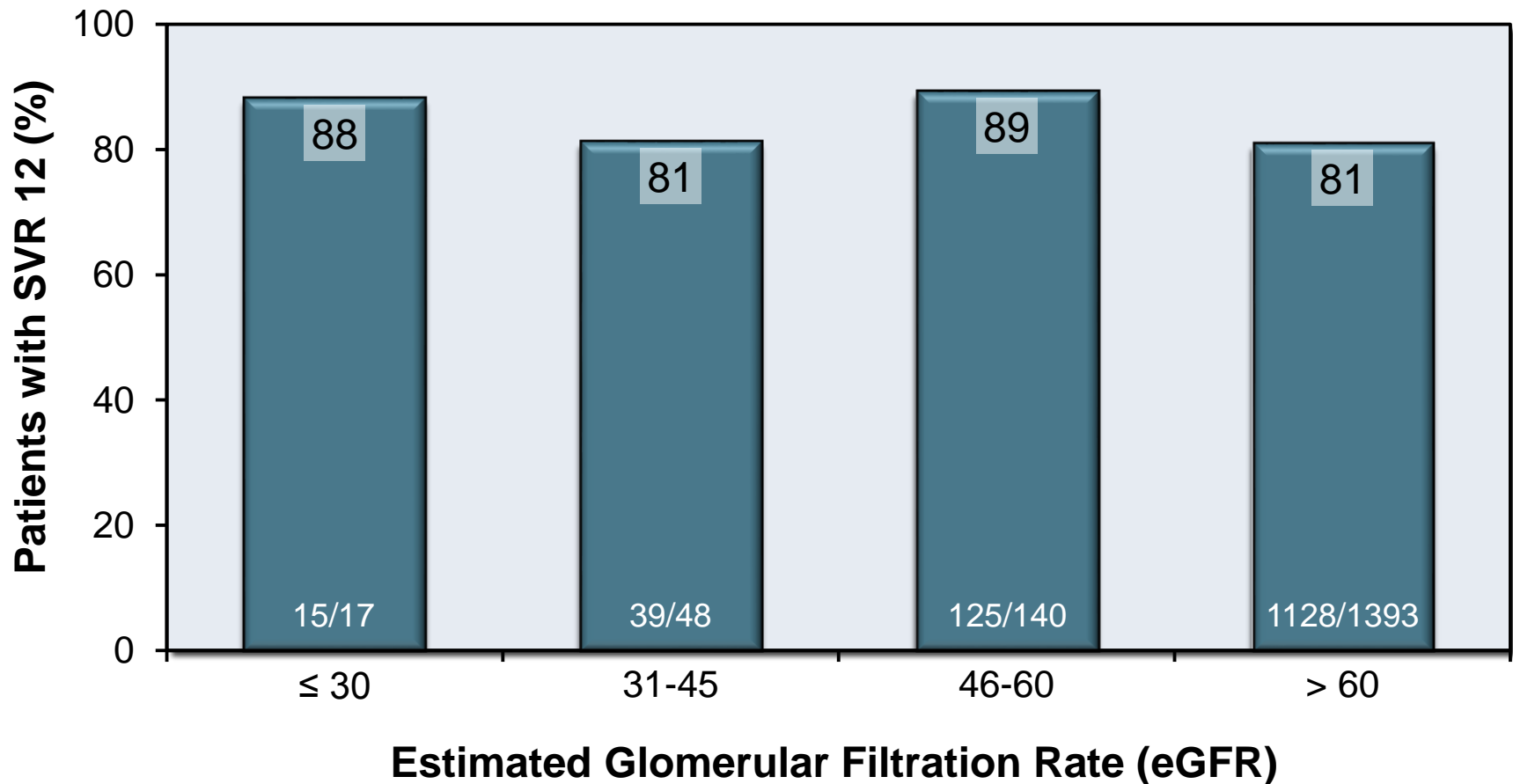

Sofosbuvir-Containing Regimens including Patients with Renal Disease HCV-TARGET Trial: Result

HCV-TARGET Trial: SVR12 Results by Baseline eGFR and Regimen

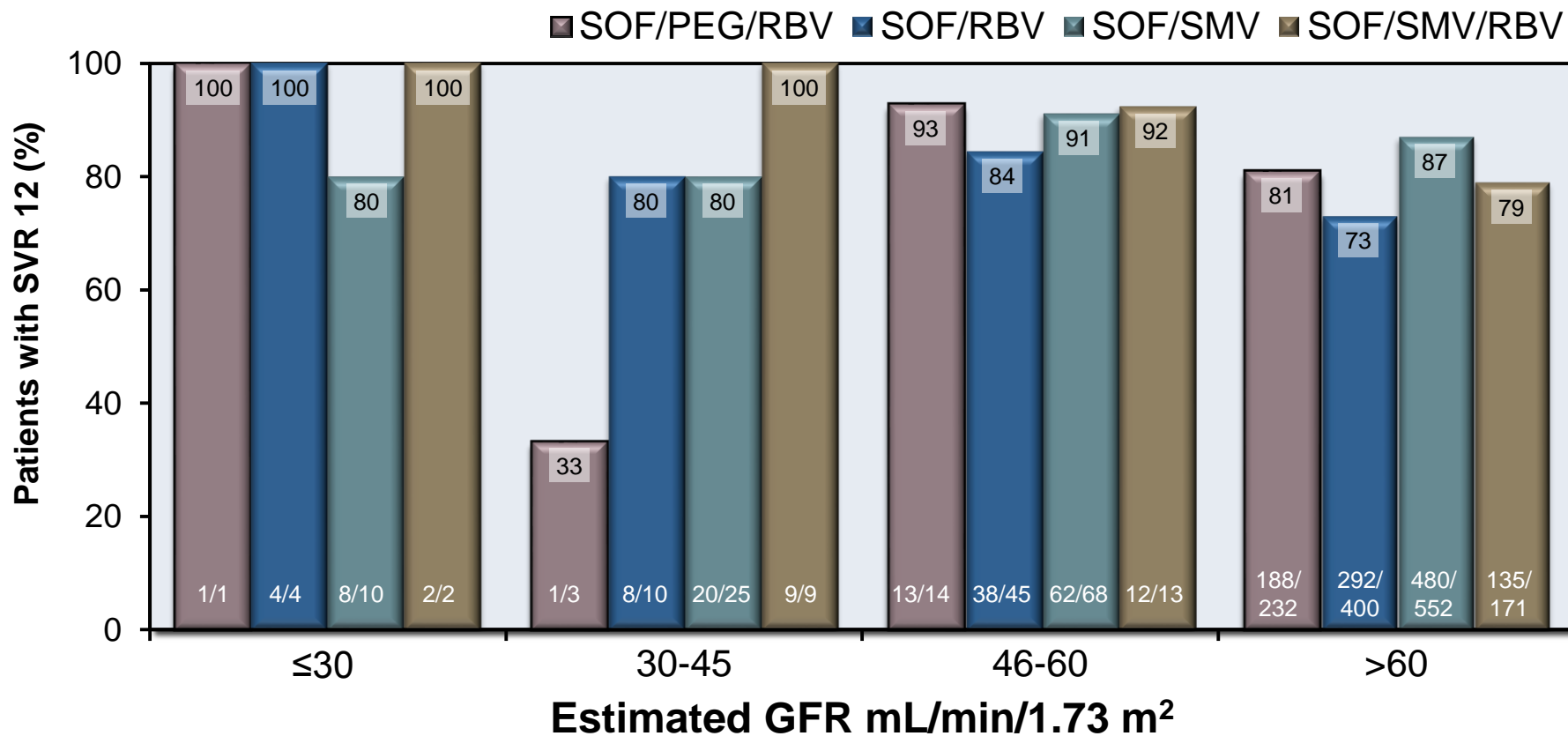

Abbreviations: SOF = sofosbuvir; PEG = peginterferon; RBV = ribavirin; SMV = simeprevir

Source: Saxena V, et al. 50th EASL. 2015; Abstract LP08.

Sofosbuvir in Patients Pre and Post Liver Transplant

Sofosbuvir + Ribavirin to Prevent Post-Transplant HCV Recurrence

Curry MP, et al. Gastroenterology. 2015;148:100-7.

Sofosbuvir + Ribavirin to Prevent Post-Transplant HCV Recurrence

Sofosbuvir + Ribavirin to Prevent Post-Transplant HCV Recurrence

- **Design:** Open-label, pilot, phase 2 trial of up to 48 weeks of sofosbuvir + ribavirin in patients with HCV of any genotype and cirrhosis awaiting liver transplantation for hepatocellular cancer
- **Setting:** International Study in United States, New Zealand, and Spain
- **Entry Criteria**
 - N = 61 patients with chronic hepatitis C and cirrhosis and any genotype
 - Age: ≥ 18
 - HCV RNA $\geq 10^4$ IU/mL
 - Treatment naïve and treatment experience
 - CTP score ≤ 7 and MELD score ≤ 17
 - Excluded if decompensated liver disease
- **Regimen Given Prior to Transplant (up to 48 weeks of therapy)**
 - Sofosbuvir + Ribavirin (weight based)
- **Primary End-Point:** SVR 12 weeks post transplant

Sofosbuvir + Ribavirin to Prevent Post-Transplant HCV Recurrence Study Design

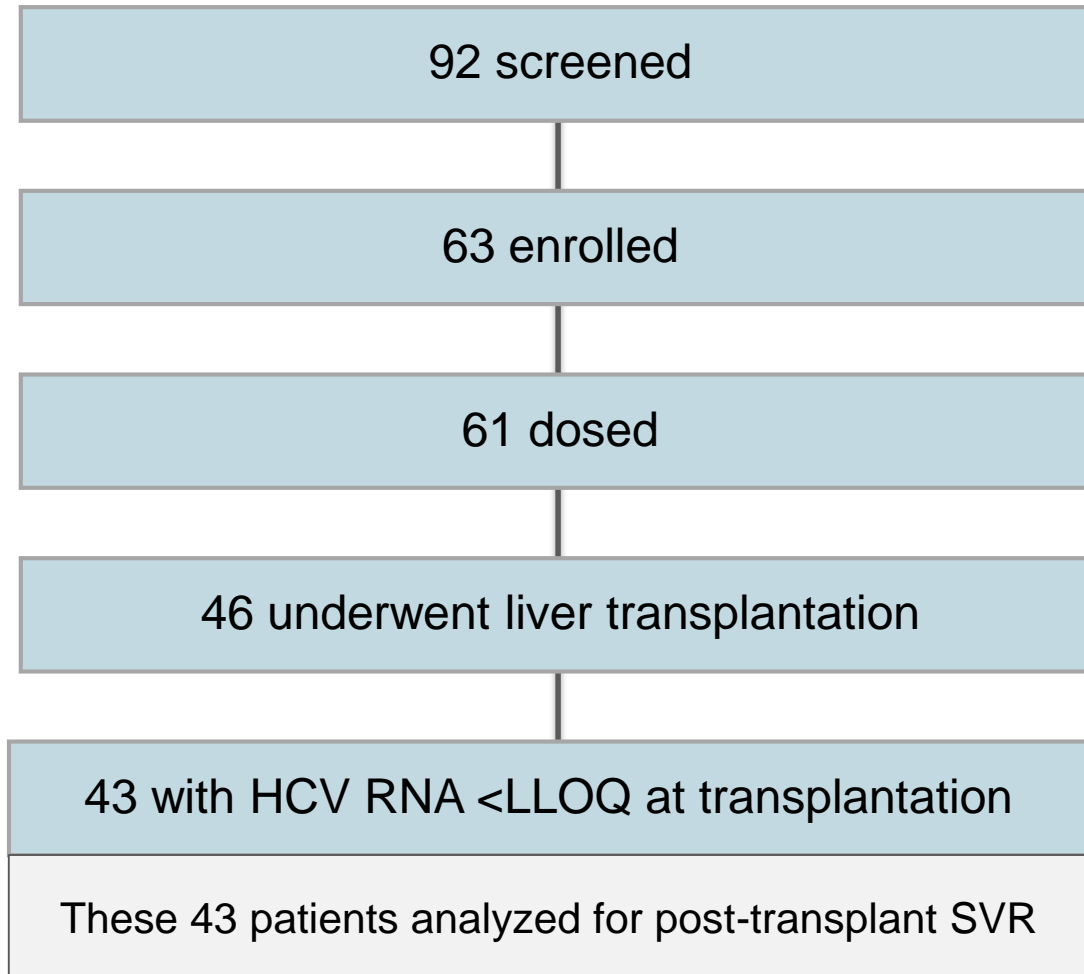

Sofosbuvir + Ribavirin to Prevent Post-Transplant HCV Recurrence Study Design

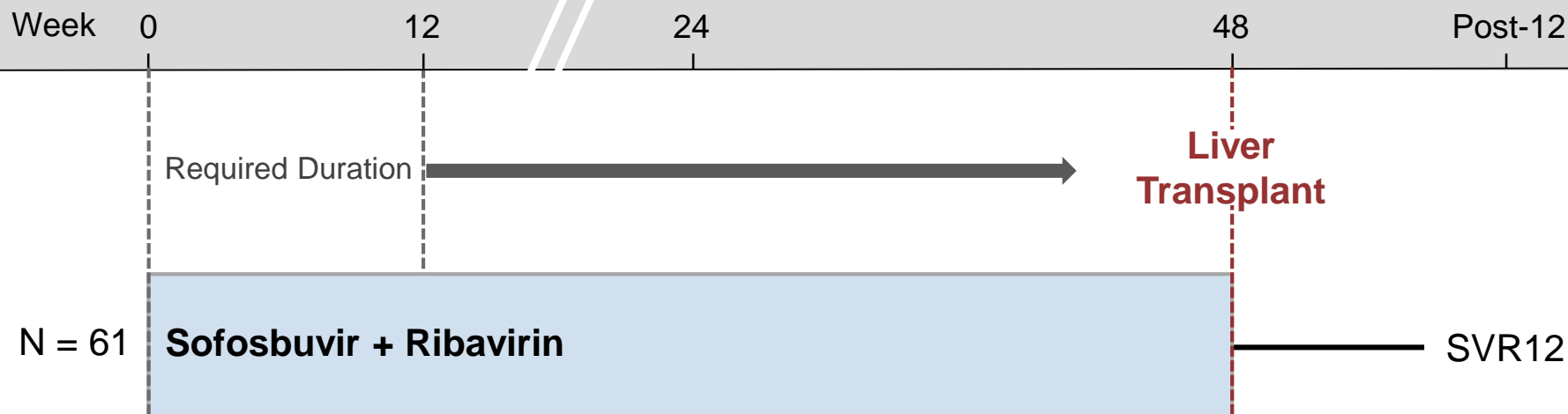

Treatment for 12 to 48 weeks while awaiting liver transplant
Dosing discontinued within 24 hours before transplantation

Drug Dosing

Sofosbuvir: 400 mg once daily

Ribavirin (weight-based and divided bid): 1000 mg/day if < 75 kg or 1200 mg/day if ≥ 75 kg

Sofosbuvir + Ribavirin to Prevent Post-Transplant HCV Recurrence

Baseline Characteristic (n = 40)	All patients dosed (N=61)	Patients with HCV RNA <25 IU/mL at time of transplant (N=43)
Median Age, years	59	59
Male sex, %	80	74
White, %	90	93
Median Body Mass Index (BMI) kg/m ²	27.4	27.1
HCV genotype 1 (%)	73	72
IL28B genotype CC, (%)	22	23
Median baseline HCV RNA, log ₁₀ IU/ml	6.2	6.3
Previous HCV treatment, %	75	79

Source: Curry MP, et al. *Gastroenterology*. 2015;148:100-7.

Sofosbuvir + Ribavirin to Prevent Post-Transplant HCV Recurrence

Virologic Response at Transplant and Post-Transplant

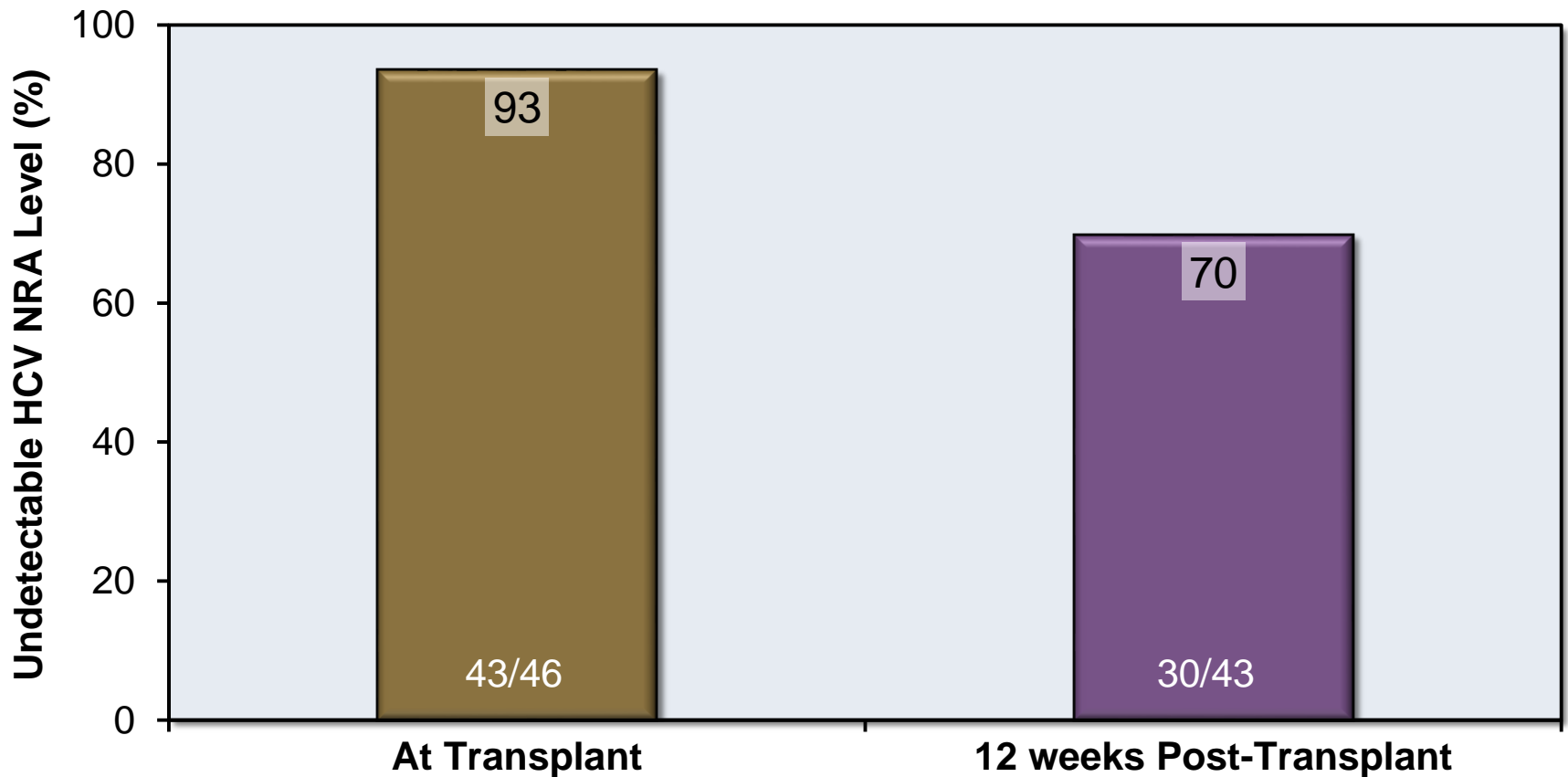

Sofosbuvir + Ribavirin to Prevent Post-Transplant HCV Recurrence

Virologic Response at Transplant and Post-Transplant

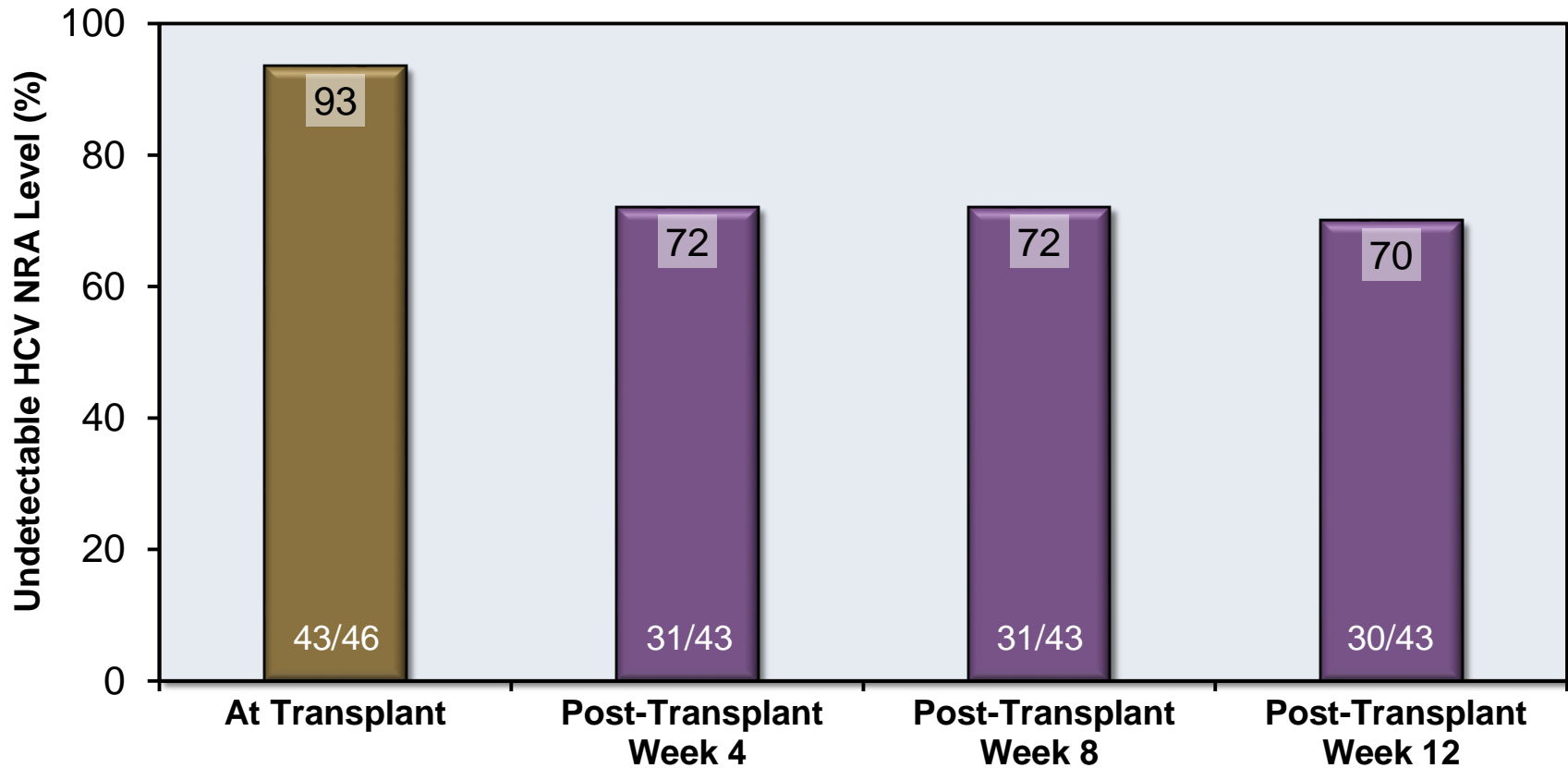

Data for the 43 patients with HCV RNA <25 IU/mL at time of transplant

Sofosbuvir + Ribavirin to Prevent Post-Transplant HCV Recurrence

Duration of Undetectable HCV RNA and Risk of Recurrence

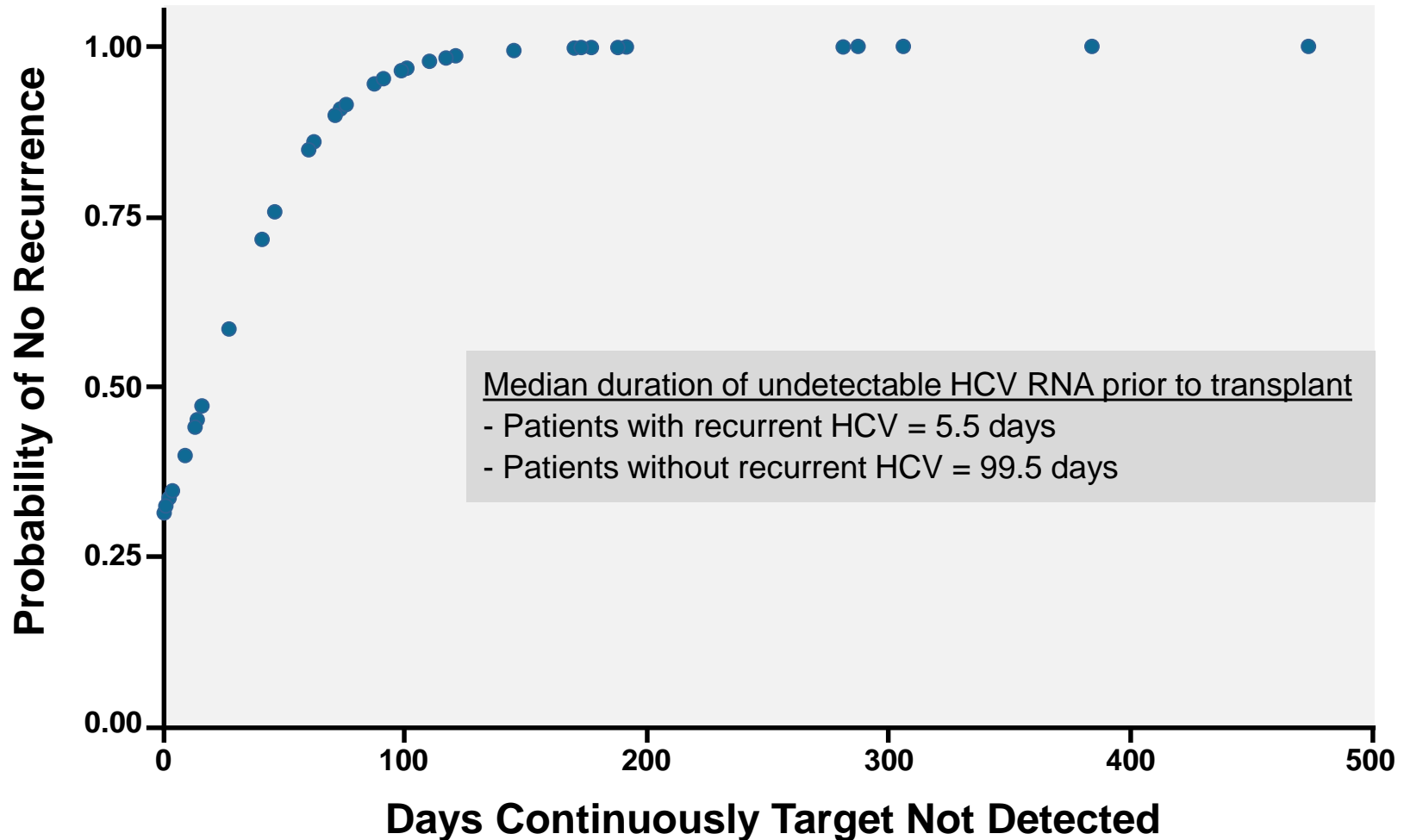

Sofosbuvir + Ribavirin to Prevent Post-Transplant HCV Recurrence

Event	Sofosbuvir + Ribavirin (N=61)
Any adverse event (%)	54 (8%)
Any serious adverse event	11 (18%)
Hemoglobin decrease to <10 g/dL	18 (30%)
Hemoglobin decrease to <8.5 g/dL	3 (5%)
Adverse event occurring in >10% of patients	
Fatigue	23 (38%)
Headache	14 (23%)
Nausea	10 (16%)
Rash	9 (15%)
Cough	7 (11%)
Dyspnea	7 (11%)
Insomnia	7 (11%)

Sofosbuvir + Ribavirin to Prevent Post-Transplant HCV Recurrence

Conclusions

Conclusions: “Administration of sofosbuvir and ribavirin before liver transplantation can prevent post-transplant HCV recurrence.”

Sofosbuvir + Ribavirin in HCV Recurrence Following Liver Transplantation

Charlton M, et al. Gastroenterology. 2015;148:108-17.

Sofosbuvir + Ribavirin in Recurrent HCV Post Liver Transplant

Sofosbuvir + Ribavirin Post Liver Transplant: Features

- **Design:** Open-label, prospective, single-arm, phase 2 trial of 24-week course of sofosbuvir + ribavirin in patients with HCV recurrence post-liver transplantation
- **Setting:** Multicenter, International Study
- **Entry Criteria**
 - N = 40 patients with chronic hepatitis C
 - Recurrent HCV infection post liver transplantation
 - Any genotype included
 - CTP score ≤ 7 and MELD score ≤ 17
 - Excluded if decompensated liver disease
- **Regimen (24 weeks)**
 - Sofosbuvir: 400 mg once daily
 - Ribavirin: started at 400 mg/day and increased up to 1200 mg/day
- **Primary End-Point:** SVR12

Sofosbuvir + Ribavirin in Recurrent HCV Post Liver Transplant

Baseline Characteristic (n = 40)	Sofosbuvir + Ribavirin x 12 weeks
Median Age, years (range)	59 (49 to 75)
Male sex, %	78
White, %	85
Median Body Mass Index (BMI) <30 kg/m ² (%)	75
HCV genotype 1 (%)	83
IL28B genotype CC, (%)	33
Median baseline HCV RNA, log ₁₀ IU/ml (range)	6.74 (4.49-7.59)
METAVIR-equivalent fibrosis (F3 or F4), %	F1-F2= 35%; F3=23%; F4=40%
Previous HCV treatment, %	88
Median time since liver transplantation, years (range)	4.3 (1.0-10.6)

Sofosbuvir + Ribavirin in Recurrent HCV Post Liver Transplant Design

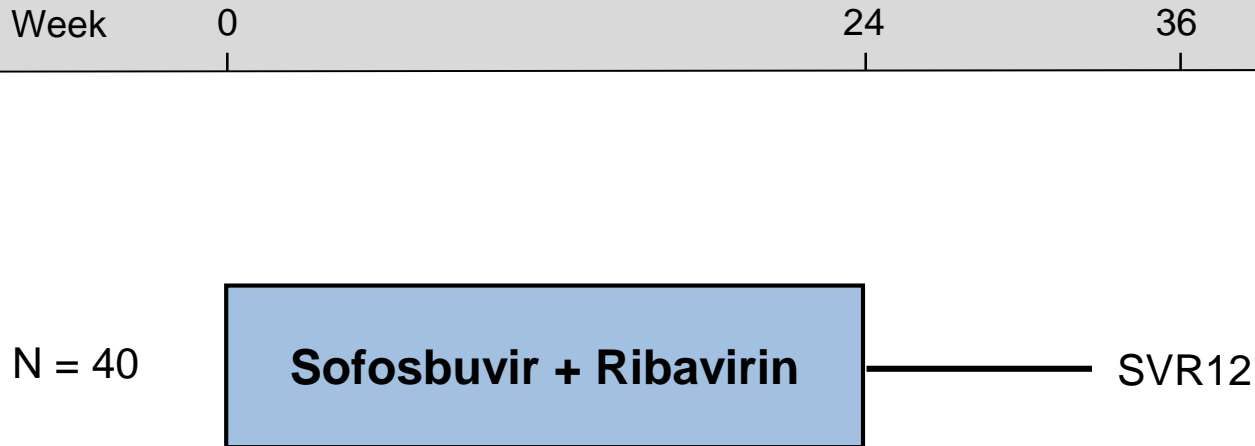

Drug Dosing

Sofosbuvir: 400 mg once daily

Ribavirin: administered in two divided daily doses (started at 400 mg/day and increased up to 1200 mg/day based on hemoglobin, creatinine clearance, and weight)

Sofosbuvir + Ribavirin in Recurrent HCV Post Liver Transplant Results

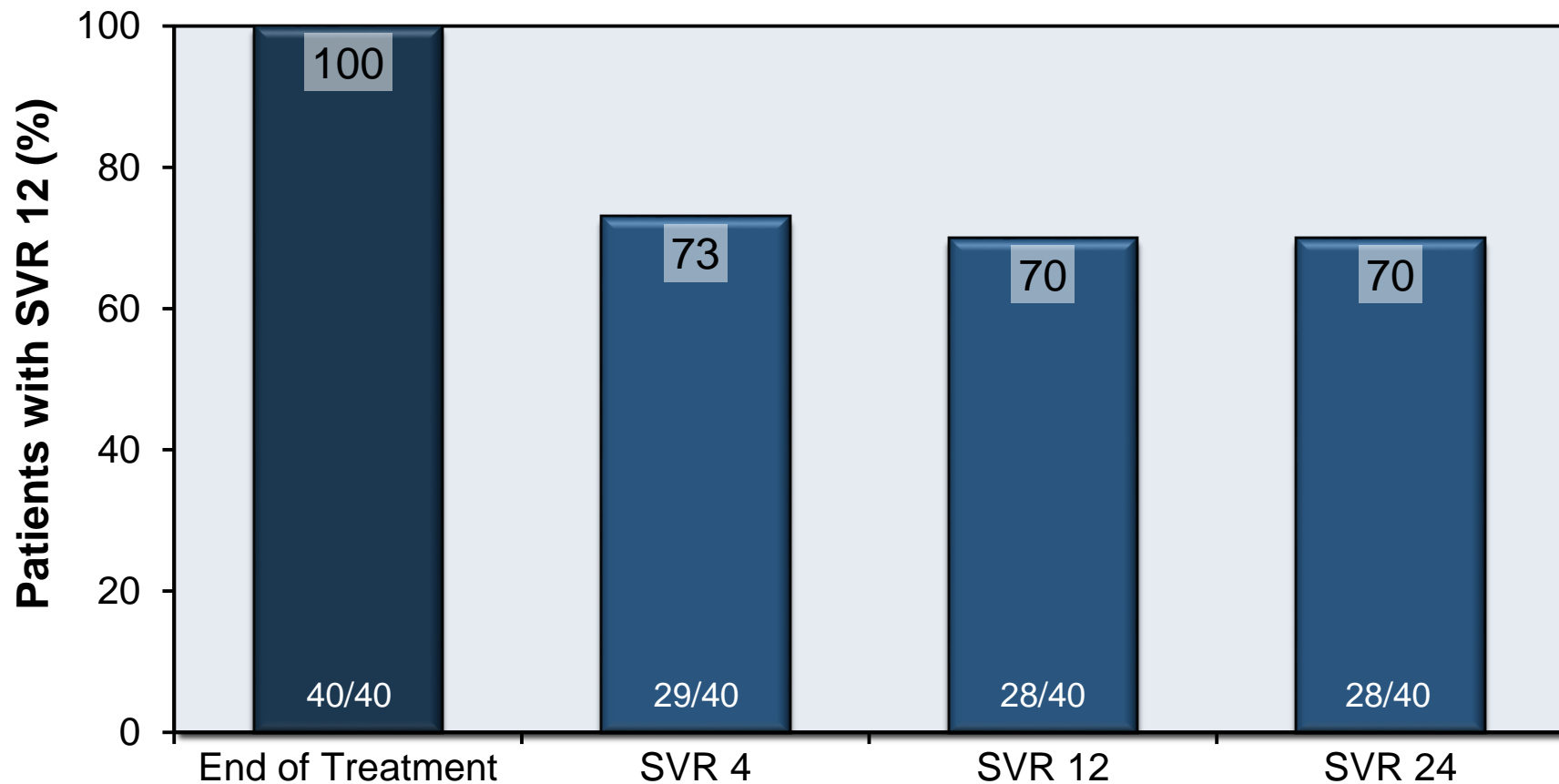

Source: Charlton M, et al. *Gastroenterology*. 2015;148:108-17.

Sofosbuvir + Ribavirin in Recurrent HCV Post Liver Transplant Adverse Effects

Event	Sofosbuvir + Ribavirin (n=40)
Any adverse event (%)	39 (98%)
Any serious adverse event	6 (15%)
Adverse event leading to discontinuation	2 (5%)
Adverse event occurring in >10% of patients	
Fatigue	12 (30%)
Diarrhea	11 (28%)
Headache	10 (25%)
Arthralgia	9 (23%)
Nausea	8 (20%)
Anemia	8 (20%)
Cough	7 (18%)
Insomnia	5 (13%)
Anxiety	5 (13%)

Source: Charlton M, et al. *Gastroenterology*. 2015;148:108-17.

Sofosbuvir + Ribavirin in Recurrent HCV Post Liver Transplant Conclusions

Conclusions: “Sofosbuvir and ribavirin combination therapy for 24 weeks is an effective and well tolerated interferon-free treatment for post-transplant HCV infection.”

Sofosbuvir + Simeprevir

Treatment Naïve and Treatment Experienced

Simeprevir + Sofosbuvir +/- Ribavirin in Genotype 1 COSMOS Trial

Lawitz E, et al. Lancet. 2014;384;1756-65.

Simeprevir + Sofosbuvir +/- Ribavirin for HCV GT 1

COSMOS Trial: Study Features

COSMOS Trial: Features

- **Design:** Randomized, phase 2a, open-label, using sofosbuvir + simeprevir +/- ribavirin in treatment naive or experienced, chronic HCV GT 1
- **Setting:** 23 centers in United States
- **Entry Criteria**
 - Chronic HCV Genotype 1
 - Age ≥ 18
 - HCV RNA greater than 10,000 IU/mL
 - Cohort 1: prior nonresponders; Metavir F0-F2
 - Cohort 2: treatment naïve & prior nonresponders; Metavir F3-F4
- **Patient Characteristics (range in different treatment arms)**
 - N = 167 (n = 80 in Cohort 1 and n = 87 in Cohort 2)
 - Baseline GT1a with Q80K: Cohort 1 = 50%; Cohort 2 = 40%
 - Non-CC IL28b Genotype: Cohort 1 = 94%; Cohort 2 = 79%
- **End-Points:** Primary = SVR12; Secondary = safety

Simeprevir + Sofosbuvir +/- Ribavirin for HCV GT 1 COSMOS Trial: Baseline Characteristic

Baseline Characteristic (n = 167)	Cohorts 1 and 2
Median Age, years (range)	57 (27-70)
Male, %	64
White, %	81
Median Body Mass Index (BMI)	28
HCV genotype	1a= 78%; 1b = 22%
IL28B non-CC genotype, (%)	86%
Mean baseline HCV RNA, log ₁₀ IU/ml	6.6
Metavir Score	F01= 20%; F2=28%; F3 = 28%; F4=25%
Previous HCV treatment	
No response (%)	76%
Treatment-naïve (%)	24%

Simeprevir + Sofosbuvir +/- Ribavirin for HCV GT 1 COSMOS Trial: Design for Cohort 1

Cohort 1: Prior Nonresponders; Metavir Scores F0-F2

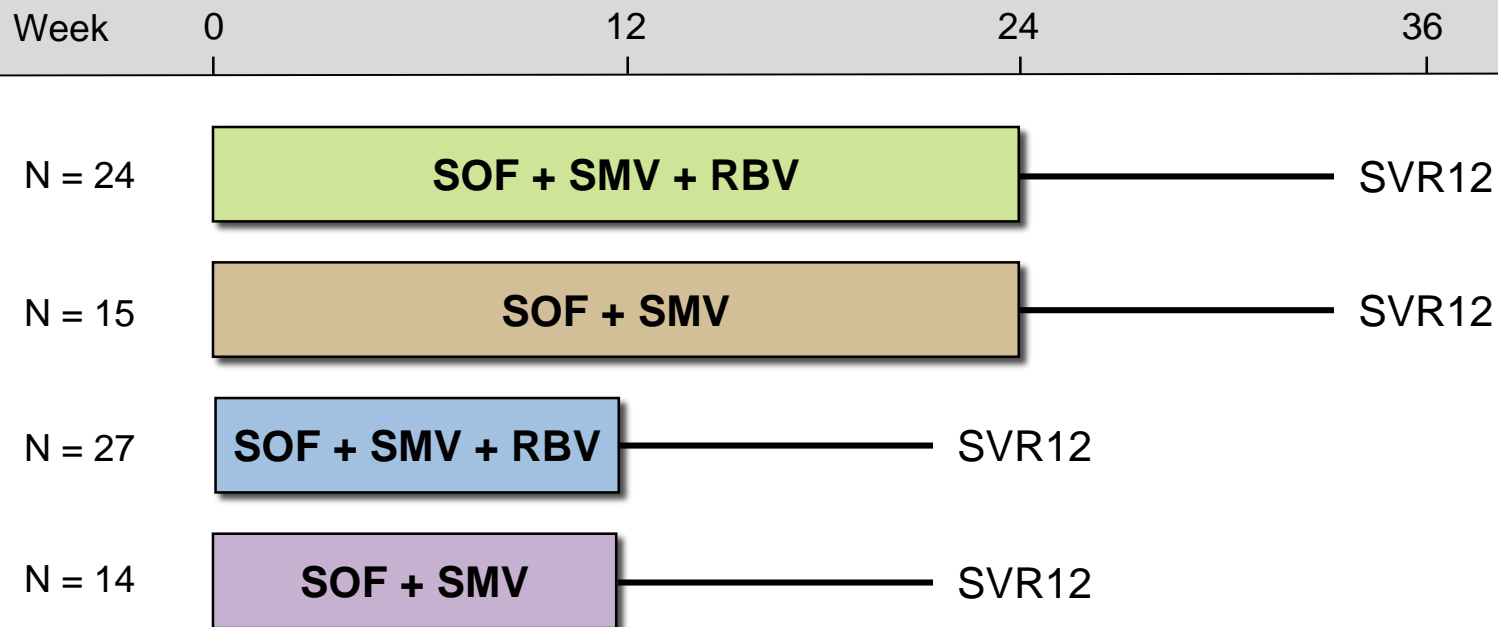

Drug Dosing

SOF= Sofosbuvir: 400 mg once daily

SMP =Simeprevir: 150 mg once daily

RBV = Ribavirin (weight-based and divided bid): 1000 mg/day if < 75 kg or 1200 mg/day if ≥ 75 kg

Simeprevir + Sofosbuvir +/- Ribavirin for HCV GT 1 COSMOS Trial: Results for Cohort 1

COSMOS (Cohort 1): SVR12 by Regimen

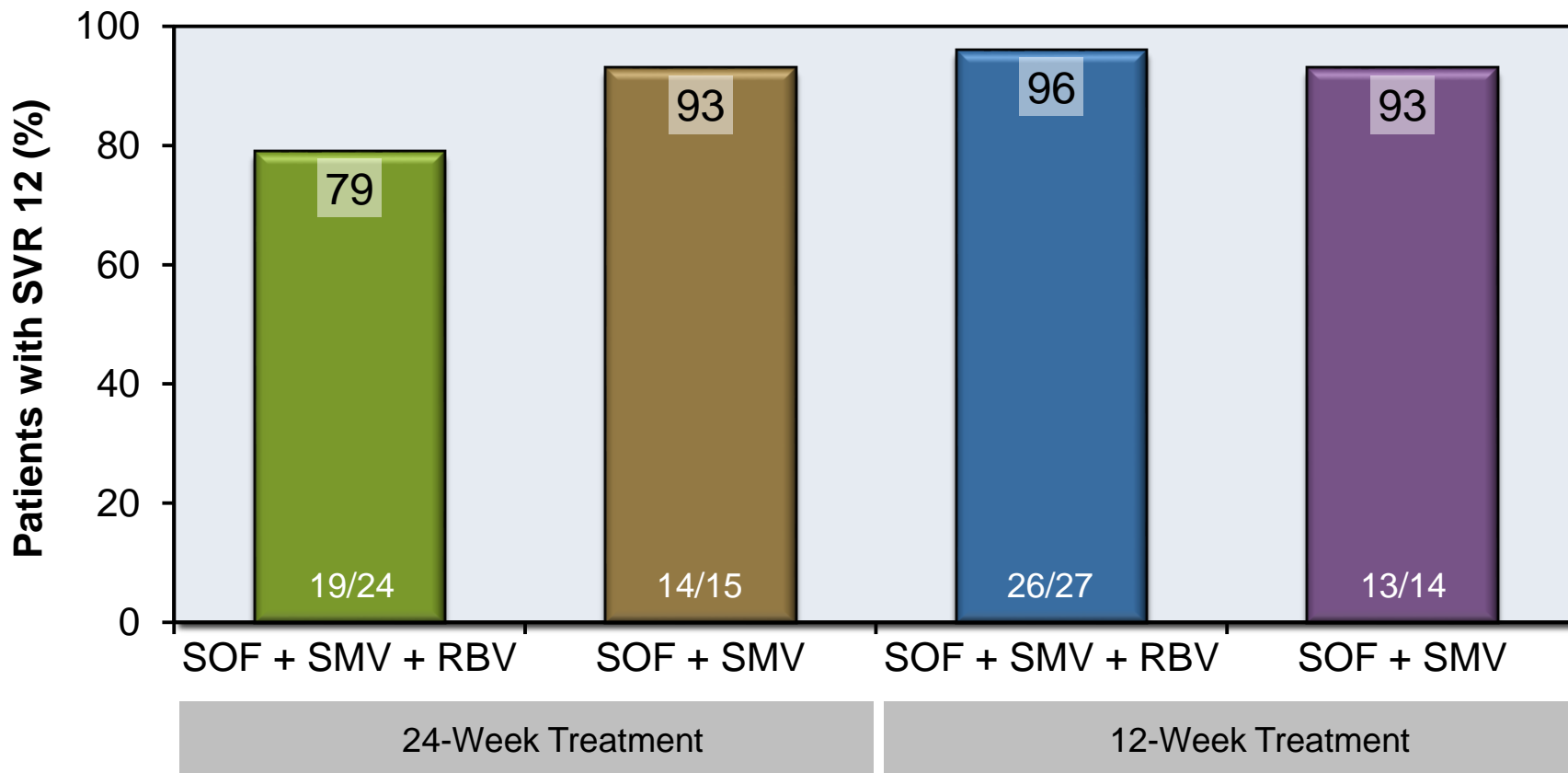

SOF = sofosbuvir; SMV = simeprevir; RBV = ribavirin

Source: Lawitz E, et al. *Lancet*. 2014;384;1756-65.

Simeprevir + Sofosbuvir +/- Ribavirin for HCV GT 1 COSMOS Trial: Design for Cohort 2

Cohort 2: Treatment Naïve & Prior Nonresponders; Metavir Scores F3-F4

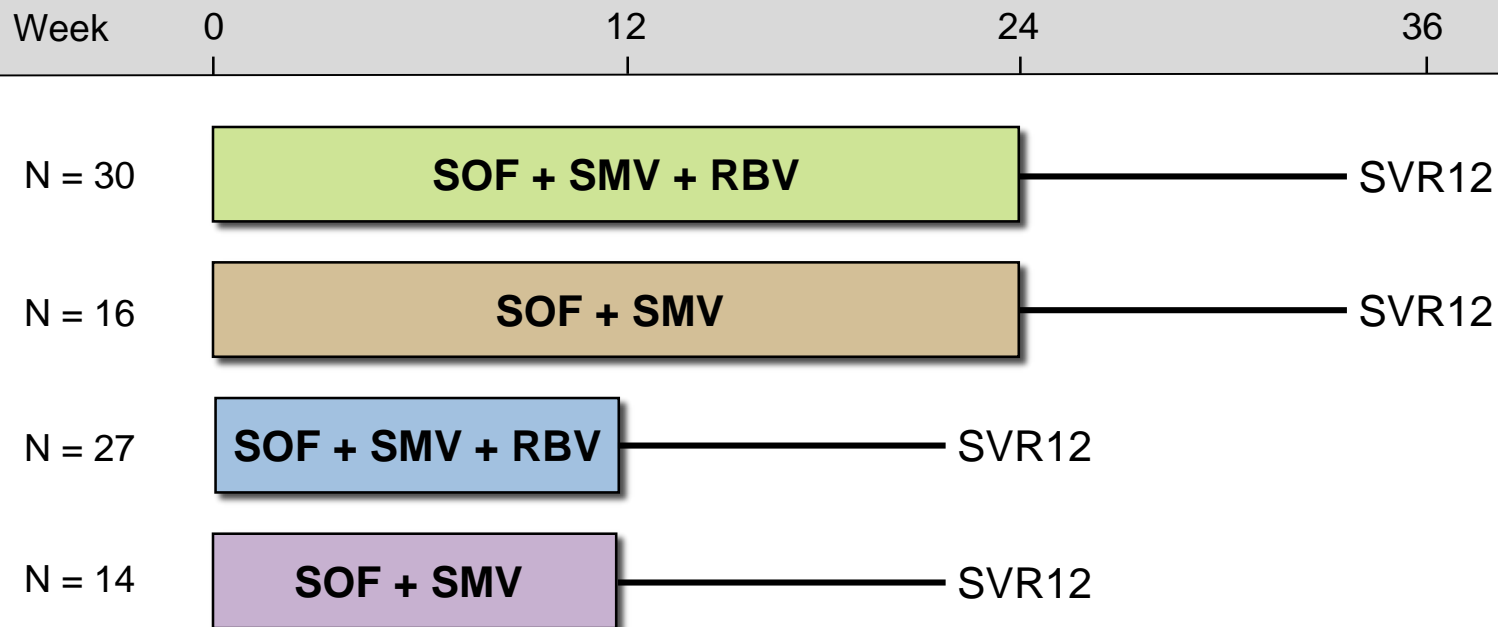

Drug Dosing

Sofosbuvir: 400 mg once daily

Simeprevir: 150 mg once daily

Ribavirin (weight-based and divided bid): 1000 mg/day if < 75 kg or 1200 mg/day if ≥ 75 kg

Simeprevir + Sofosbuvir +/- Ribavirin for HCV GT 1 COSMOS Trial: Results

COSMOS (Cohort 2 with F3-F4 Fibrosis): SVR12 by Regimen

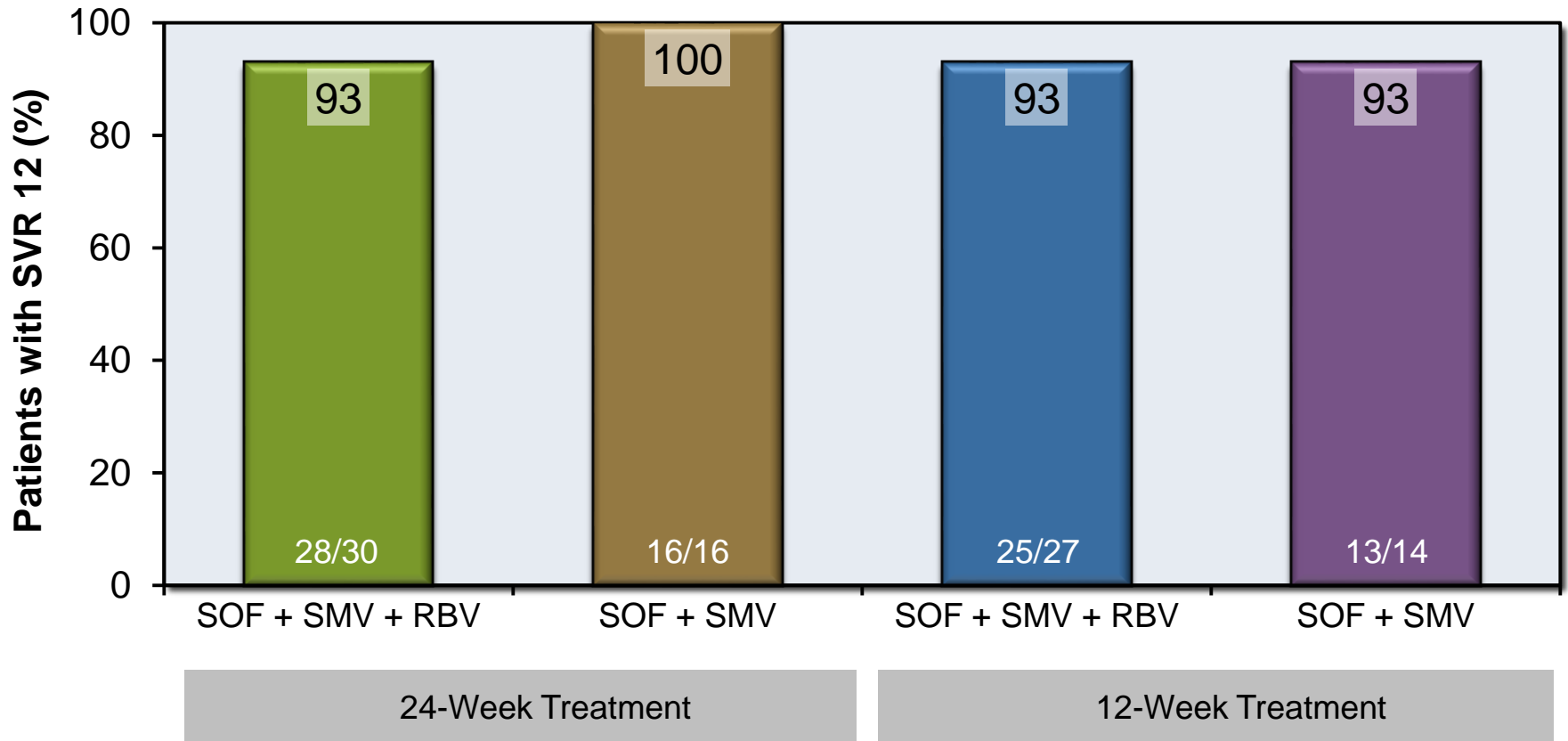

SOF = sofosbuvir; SMV = simeprevir; RBV = ribavirin

Source: Lawitz E, et al. *Lancet*. 2014;384;1756-65.

Simeprevir + Sofosbuvir +/- Ribavirin for HCV GT 1 COSMOS Trial: Results for Cohort 1 & 2

Cohort 1 & 2: SVR12

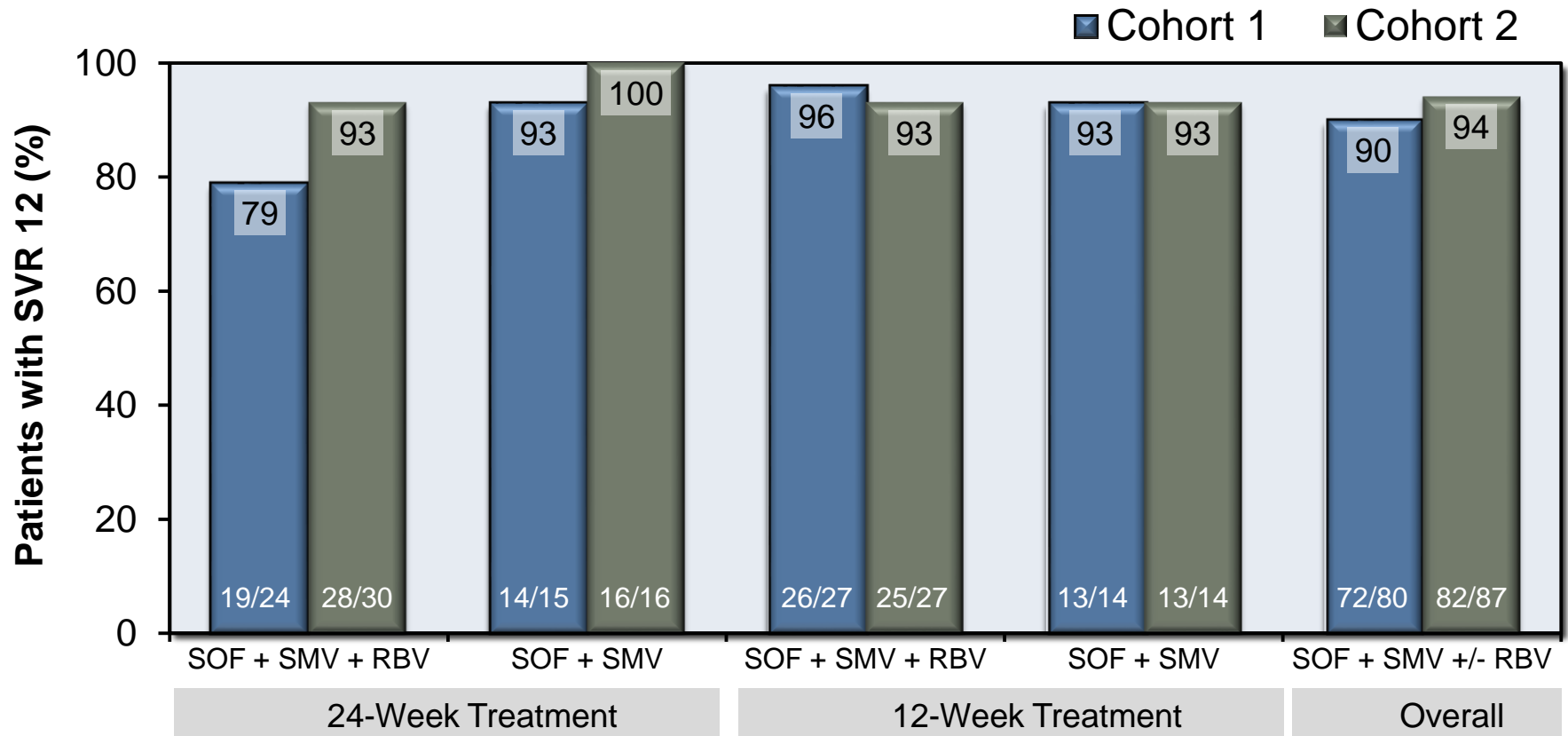

Simeprevir + Sofosbuvir +/- Ribavirin for HCV GT 1 COSMOS Trial: Results for Cohort 1 & 2

Cohort 1 & 2: SVR12 (Non-VR excluded analysis*)

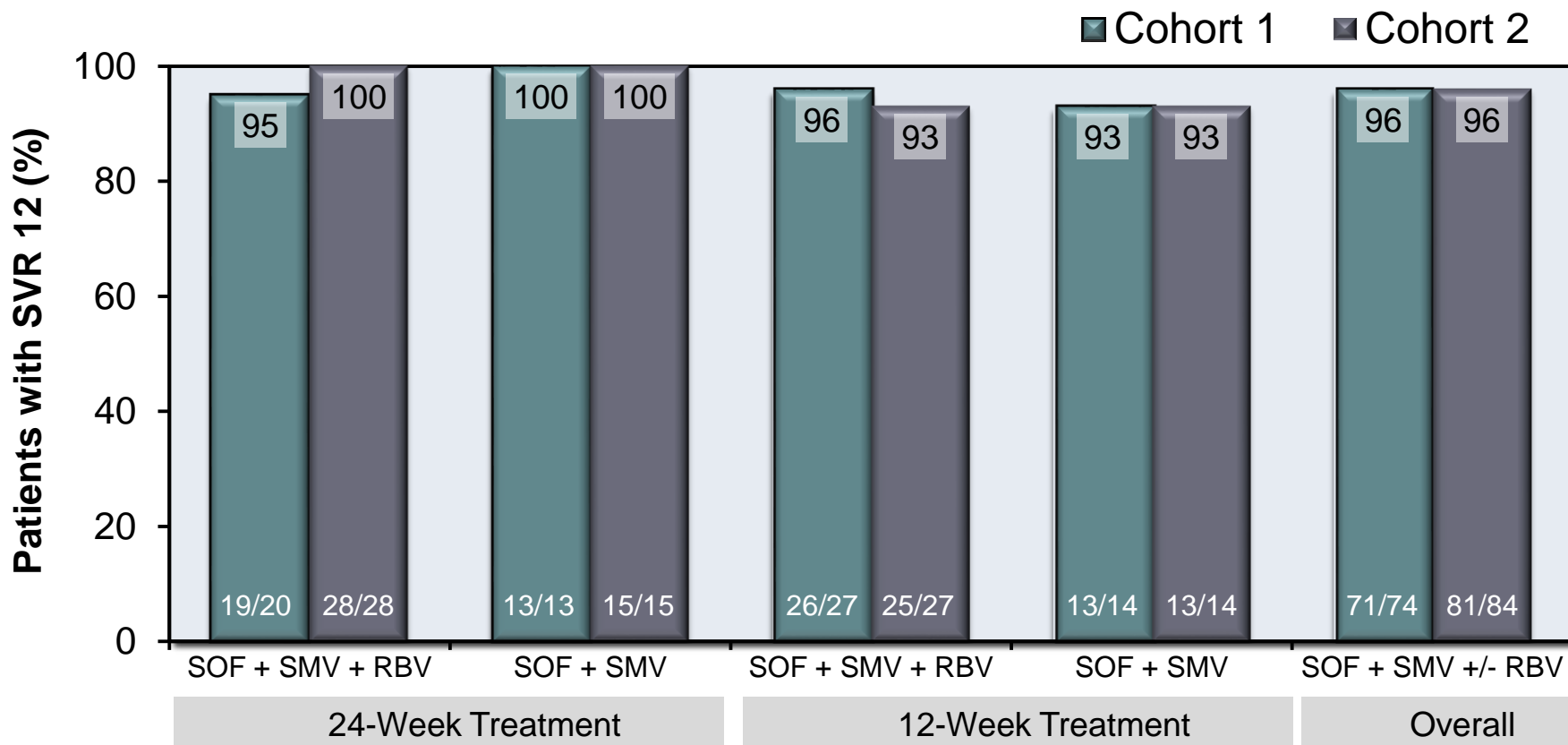

*Non-VR excluded analysis = SVR12 excludes early discontinuation due to non-virologic reasons or missing data at SVR12 time point

Simeprevir + Sofosbuvir +/- Ribavirin for HCV GT 1 COSMOS Trial: Results for Cohort 1 & 2

Impact of Q80K on SVR in Patients with GT1

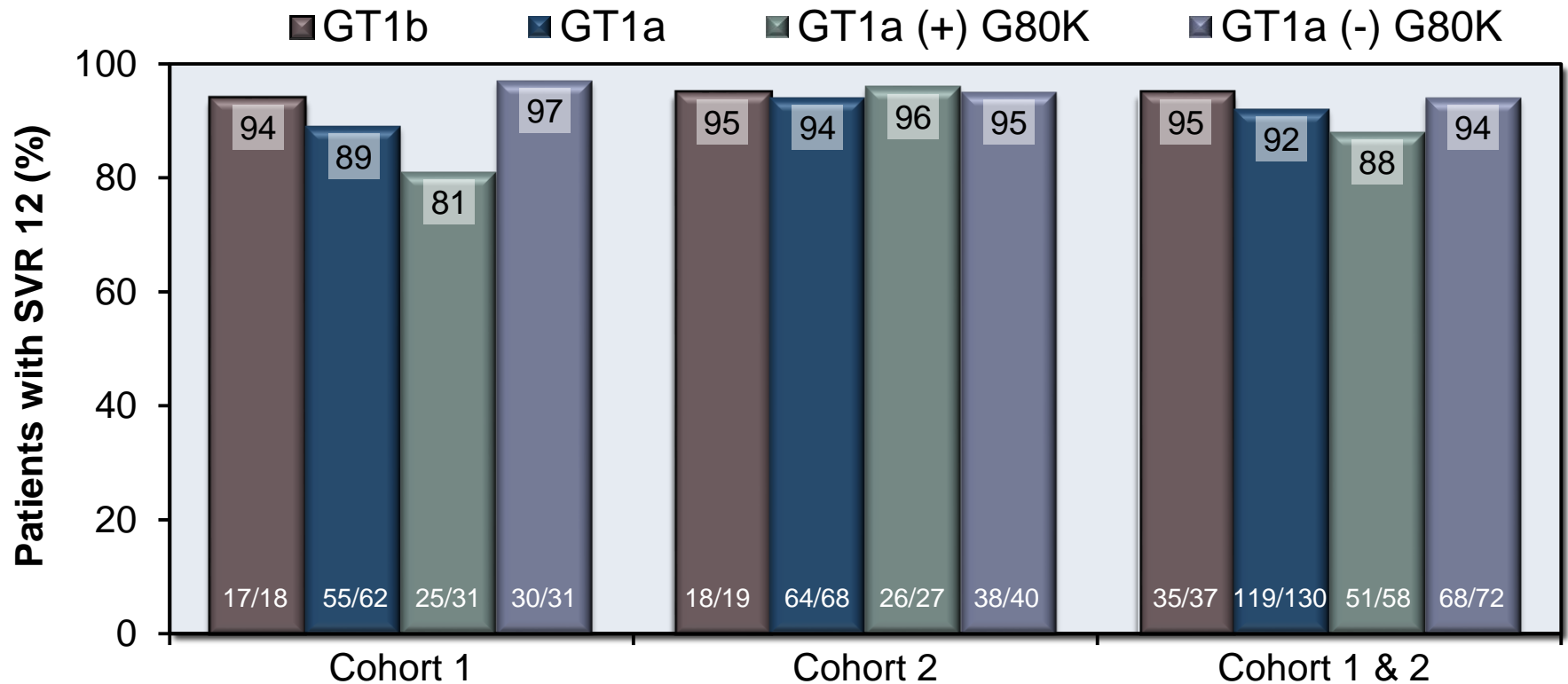

*G80K = Gln80Lys

Source: Lawitz E, et al. Lancet. 2014;384;1756-65.

Simeprevir + Sofosbuvir +/- Ribavirin for HCV GT 1 COSMOS Trial: Interpretation

Interpretation: “Combined simeprevir and sofosbuvir was efficacious and well tolerated.”

Treatment Naïve and Treatment Experienced

Simeprevir + Sofosbuvir in GT1 without Cirrhosis OPTIMIST-1 Trial

Kwo P, et al. 50th EASL; 2015. Abstract LB14.

Simeprevir + Sofosbuvir for HCV GT 1 without Cirrhosis

OPTIMIST-1 Trial: Study Features

OPTIMIST 1 Trial: Features

- **Design:** Randomized, phase 3, open-label, using sofosbuvir plus simeprevir for 8 or 12 weeks in treatment naive or experienced patients with chronic HCV genotype 1 infection without cirrhosis
- **Setting:** multicenter in United States and Canada
- **Entry Criteria**
 - Chronic HCV Genotype 1a or 1b
 - Documented lack of cirrhosis
 - Age 18-70
 - HCV RNA greater than 10,000 IU/mL
 - Treatment experienced required to have ≥ 1 INF-based regimen +/- RBV
- **Exclusion**
 - Cirrhosis, hepatic decompensation, or non-HCV-related liver disease
 - Coinfection with HBV or HIV
- **End-Points:** Primary = SVR12 by intent-to-treat analysis

Simeprevir + Sofosbuvir for HCV GT 1 without Cirrhosis OPTIMIST-1 Trial: Study Design

Week 0 8 12 20 24

GT-1
Naïve/Experienced
Noncirrhotic

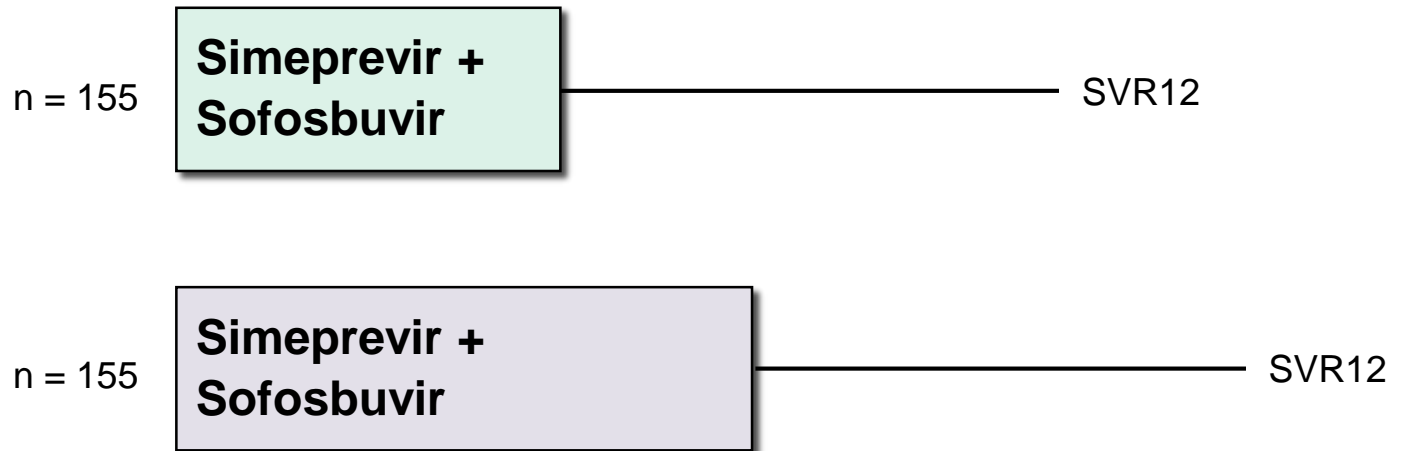

Drug Dosing

Simeprevir: 150 mg once daily

Sofosbuvir: 400 mg once daily

Simeprevir + Sofosbuvir for HCV GT 1 without Cirrhosis OPTIMIST-1 Trial: Results

OPTIMIST 1: SVR12, by Treatment Experience

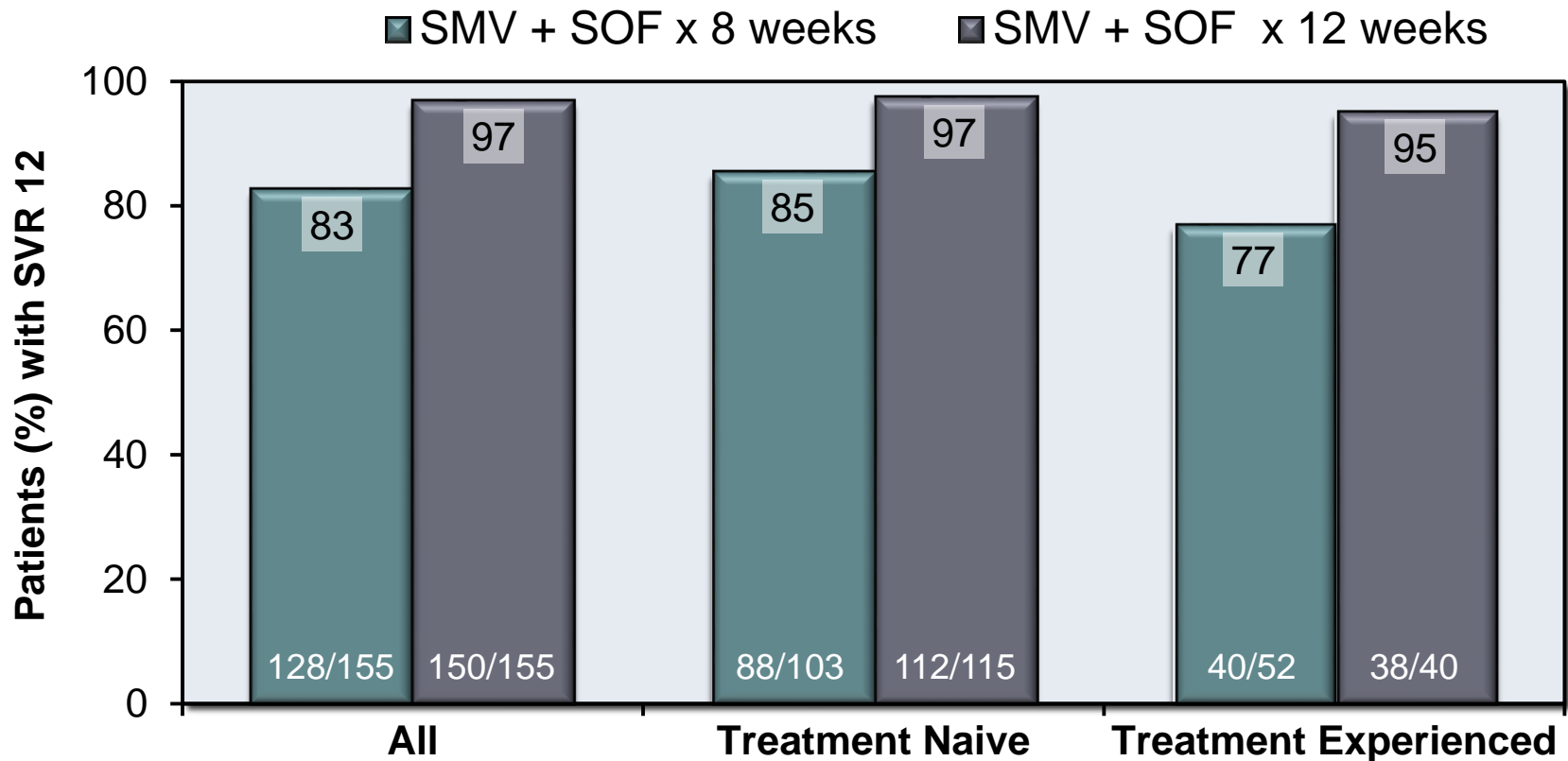

SVR12 = sustained virologic response at 12 weeks

Source: Kwo P, et al. 50th EASL; 2015. Abstract LB14.

Simeprevir + Sofosbuvir for HCV GT 1 without Cirrhosis OPTIMIST-1 Trial: Results

OPTIMIST 1: SVR12, by Genotype 1 Subtype

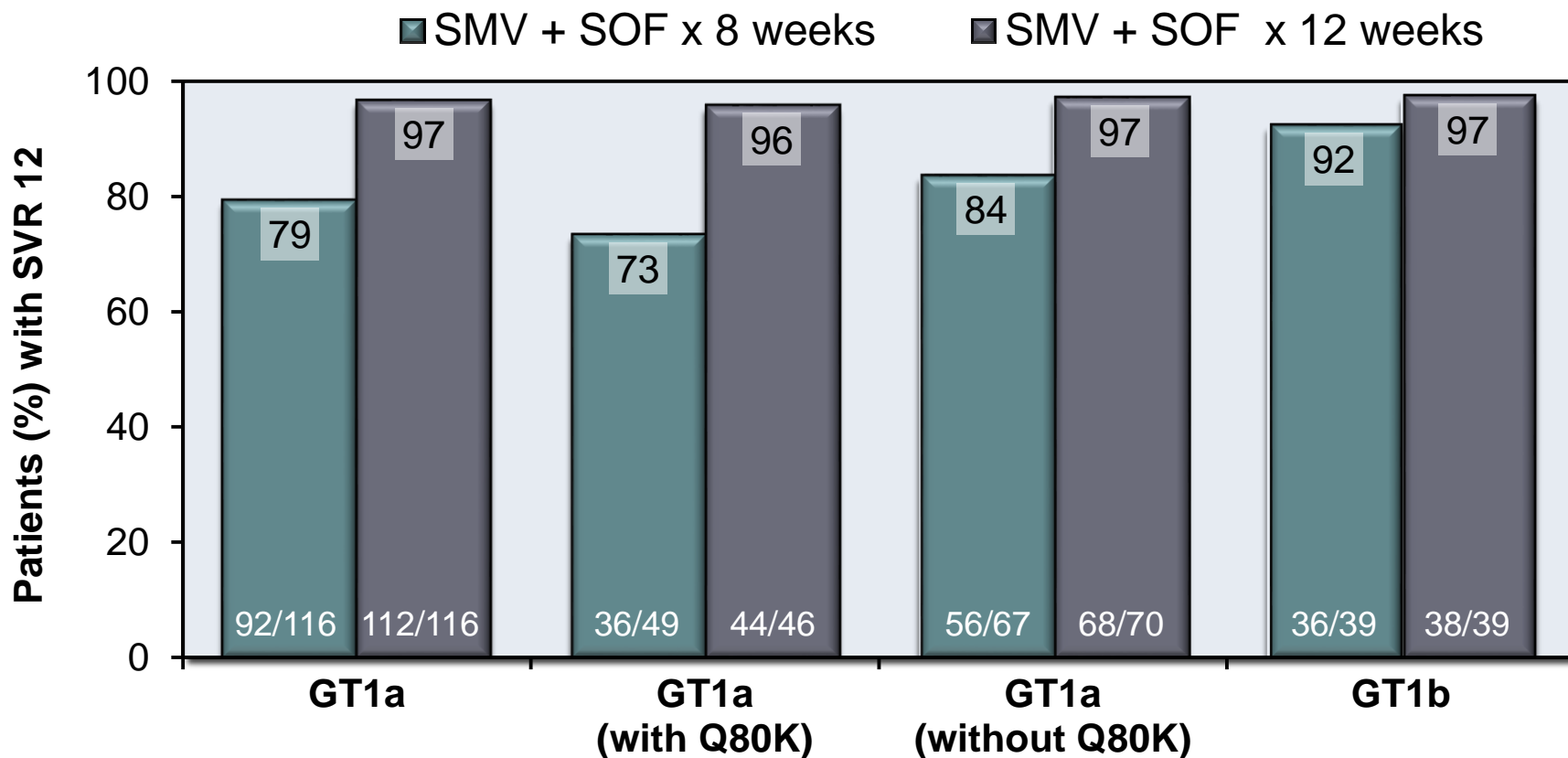

SVR12 = sustained virologic response at 12 weeks

Source: Kwo P, et al. 50th EASL; 2015. Abstract LB14.

Treatment Naïve and Treatment Experienced

Simeprevir + Sofosbuvir in GT1 with Cirrhosis OPTIMIST-2 Trial

Lawitz E, et al. 50th EASL; 2015. Abstract LP04.

Simeprevir + Sofosbuvir for HCV GT 1 with Cirrhosis

OPTIMIST-2 Trial: Study Features

OPTIMIST 2 Trial: Features

- **Design:** Randomized, phase 3, open-label, single-arm trial using sofosbuvir plus simeprevir for 12 weeks in treatment naive or experienced patients with chronic HCV genotype 1 infection and compensated cirrhosis
- **Setting:** multicenter in United States and Canada
- **Entry Criteria**
 - Chronic HCV Genotype 1 infection
 - Studies indicating cirrhosis with compensation
 - Age 18-70
 - HCV RNA greater than 10,000 IU/mL
 - Any treatment history allowed
- **Exclusion**
 - Hepatic decompensation, or non-HCV-related liver disease
 - Coinfection with HBV or HIV
- **End-Points:** Primary = SVR12 by intent-to-treat analysis

Simeprevir + Sofosbuvir for HCV GT 1 with Cirrhosis OPTIMIST-2 Trial: Study Design

Week

0

12

24

GT-1

Naïve/Experienced

Compensated Cirrhosis

n = 103

Simeprevir + Sofosbuvir

SVR12

Drug Dosing

Simeprevir: 150 mg once daily

Sofosbuvir: 400 mg once daily

Simeprevir + Sofosbuvir for HCV GT 1 with Cirrhosis OPTIMIST-2 Trial: Results

OPTIMIST 2: SVR12, by Treatment Experience

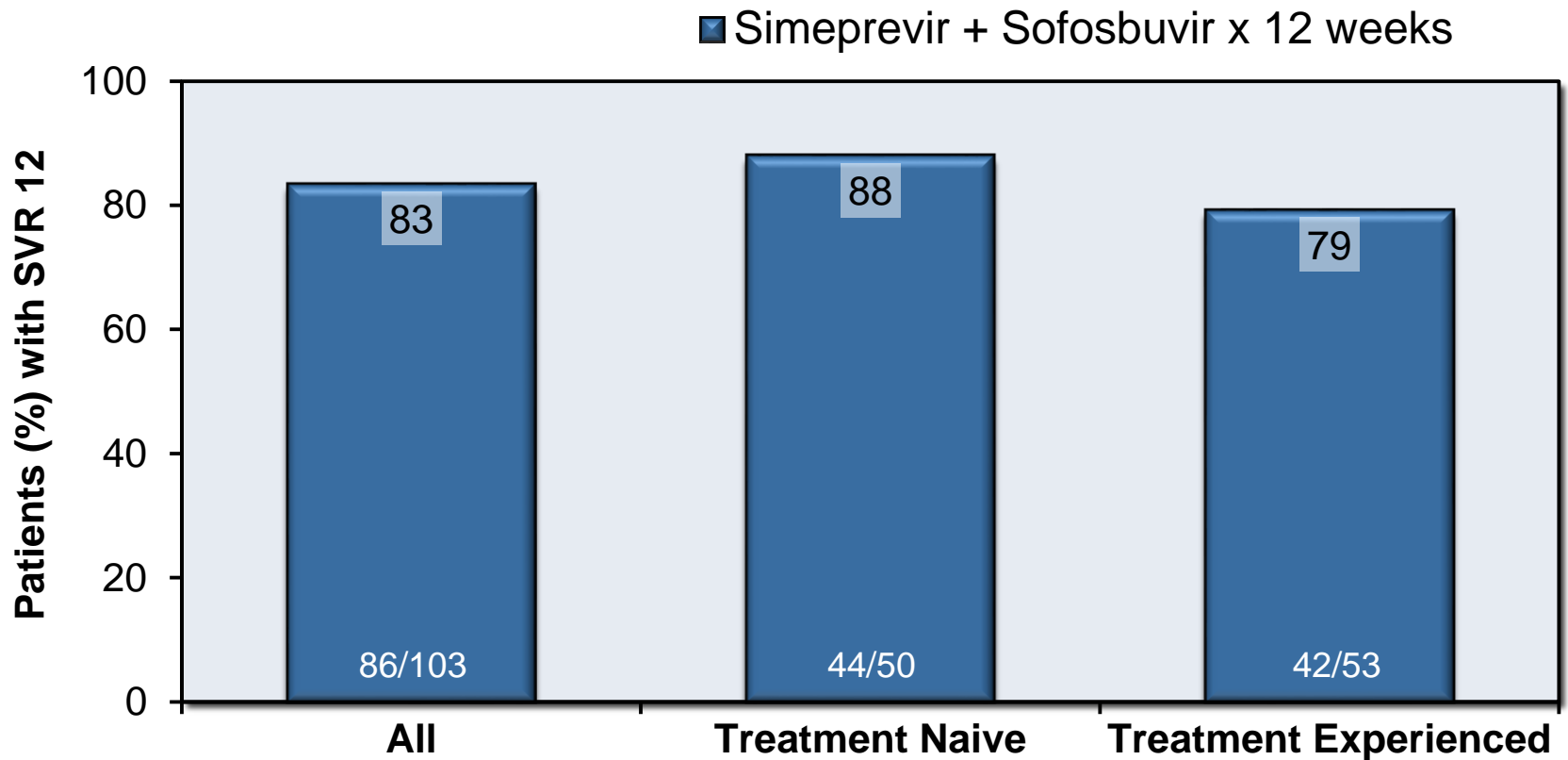

SVR12 = sustained virologic response at 12 weeks

Source: Lawitz E, et al. 50th EASL; 2015. Abstract LP04.

Simeprevir + Sofosbuvir for HCV GT 1 with Cirrhosis OPTIMIST-2 Trial: Results

OPTIMIST 2: SVR12, by Genotype 1 Subtype

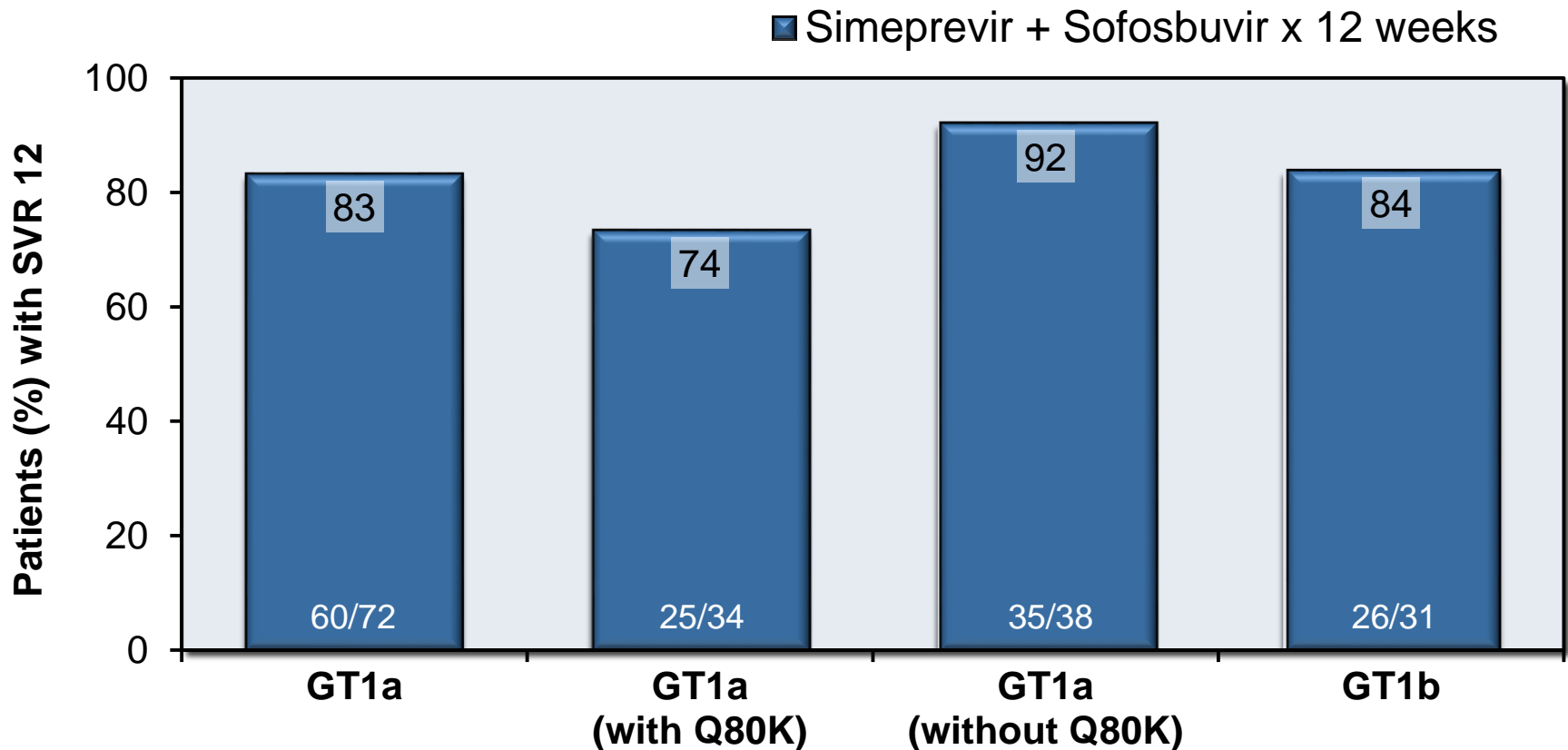

SVR12 = sustained virologic response at 12 weeks

Source: Lawitz E, et al. 50th EASL; 2015. Abstract LP04.

Sofosbuvir + Daclatasvir

Treatment Naïve and Treatment Experienced

Daclatasvir + Sofosbuvir +/- Ribavirin in Genotypes 1-3 A1444-040 Trial

Sulkowski MS, et al. N Engl J Med. 2014;370:211-21.

Daclatasvir + Sofosbuvir +/- Ribavirin for HCV GT 1-3 A1444-040 Trial: Features

Daclatasvir + Sofosbuvir Trial: Features

- **Design:** Randomized, open label, phase 2a, using daclatasvir + sofosbuvir +/- ribavirin in treatment naïve or experienced, chronic HCV GT 1-3
- **Setting:** United States
- **Entry Criteria**
 - Chronic HCV Genotype 1, 2, or 3
 - Treatment naïve or treatment experienced
 - No evidence of cirrhosis
- **Patient Groups**
 - N = 211 total received treatment
 - N = 44 Rx naïve with GT1: DCV+ SOF +/- RBV x 24 weeks
 - N = 44 Rx naïve patients with GT 2 or 3: DCV+ SOF +/- RBV x 24 weeks
 - N = 123 Rx naïve or experienced with GT 1: DCV+ SOF +/- RBV x 12 weeks
- **End-Points:** Primary = SVR12

Daclatasvir + Sofosbuvir +/- Ribavirin for HCV GT 1-3

A1444-040 Design: Treatment-Naïve 24 Week Rx

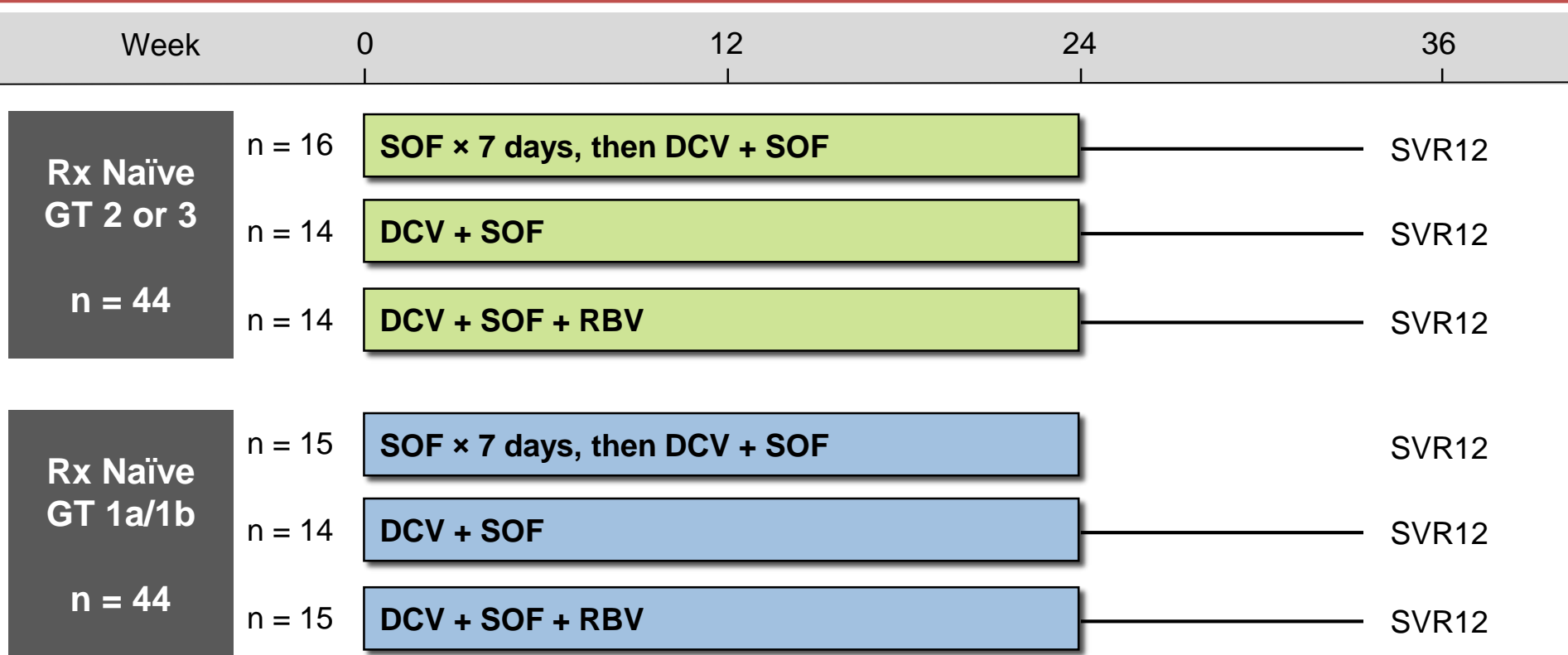

Drug Dosing

Daclatasvir (DCV): 60 mg once daily

Sofosbuvir (SOF): 400 mg once daily

Ribavirin (RBV): GT1, given weight-based and divided bid (1000 mg/day if < 75 kg or 1200 mg/day if ≥ 75 kg)

Ribavirin (RBV): GT 2,3 (800 mg/day)

Daclatasvir + Sofosbuvir +/- Ribavirin for HCV GT 1-3

Design: GT1 Treatment-Naïve & Experienced 12 Week Rx

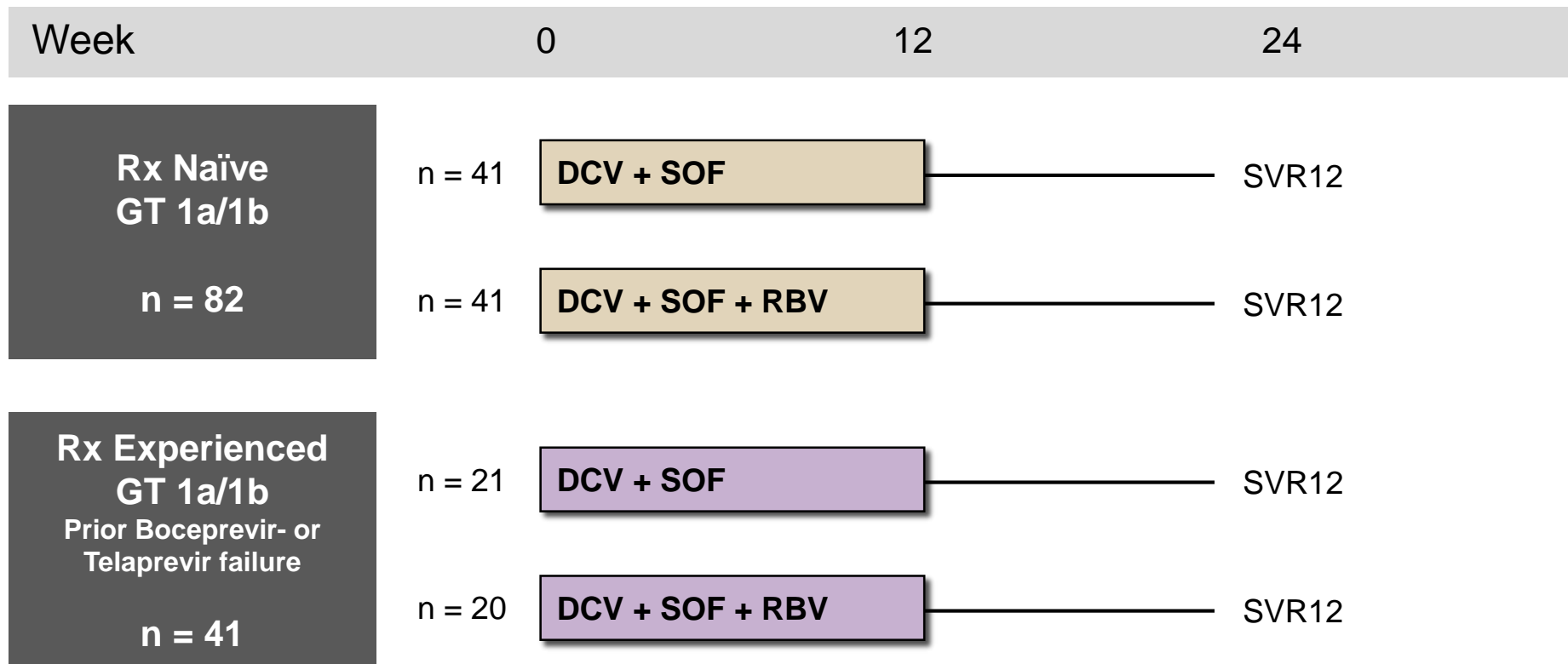

Drug Dosing

Daclatasvir (DCV): 60 mg once daily

Sofosbuvir (SOF): 400 mg once daily

Ribavirin (RBV): GT1, given weight-based and divided bid (1000 mg/day if < 75 kg or 1200 mg/day if ≥ 75 kg)

Ribavirin (RBV): GT 2,3 (800 mg/day)

Daclatasvir + Sofosbuvir +/- Ribavirin for HCV GT 1-3 A1444-040 Treatment-Naïve 24 Week Rx: Results

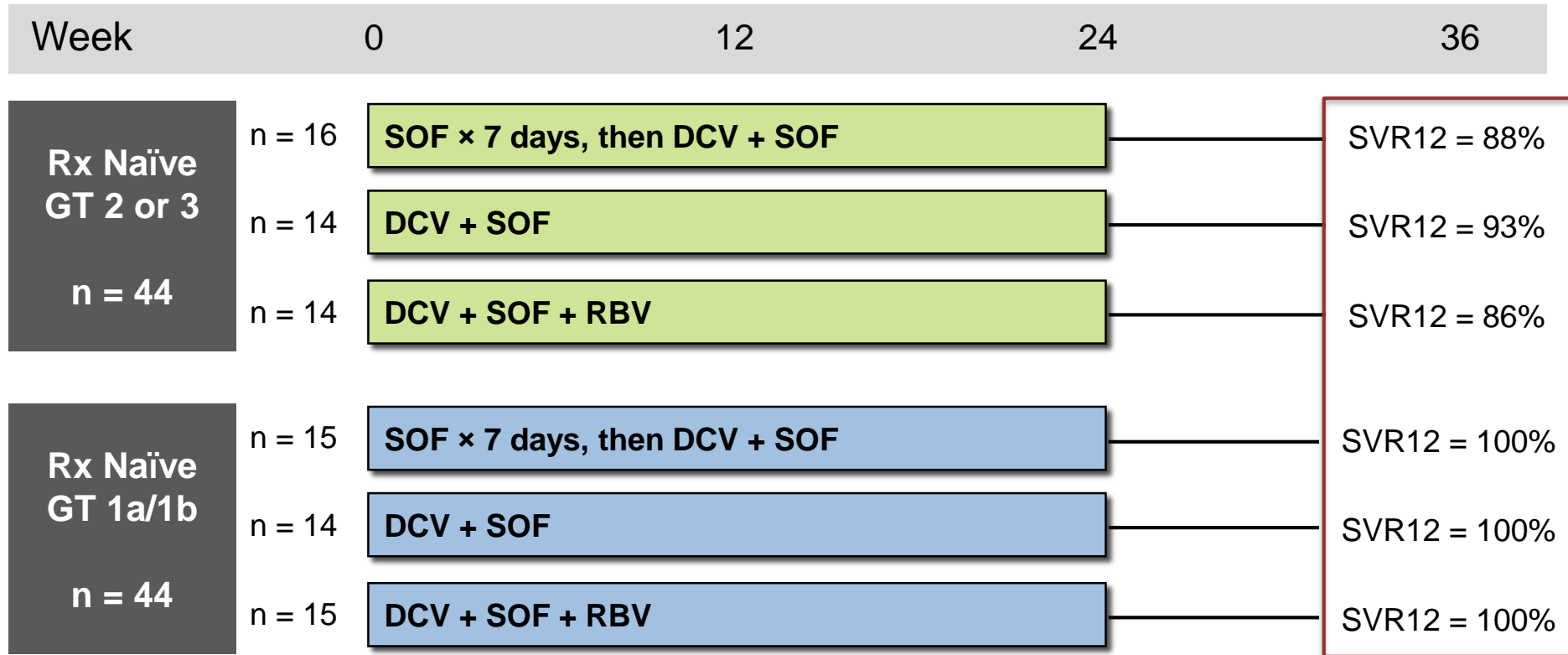

Drug Dosing

Daclatasvir (DCV): 60 mg once daily

Sofosbuvir (SOF): 400 mg once daily

Ribavirin (RBV): GT 1, given weight-based and divided bid (1000 mg/day if < 75 kg or 1200 mg/day if ≥ 75 kg)

Ribavirin (RBV): GT 2,3 (800 mg/day)

Daclatasvir + Sofosbuvir +/- Ribavirin for HCV GT 1-3 A1444-040 Treatment-Naïve 24 Week Rx: Results

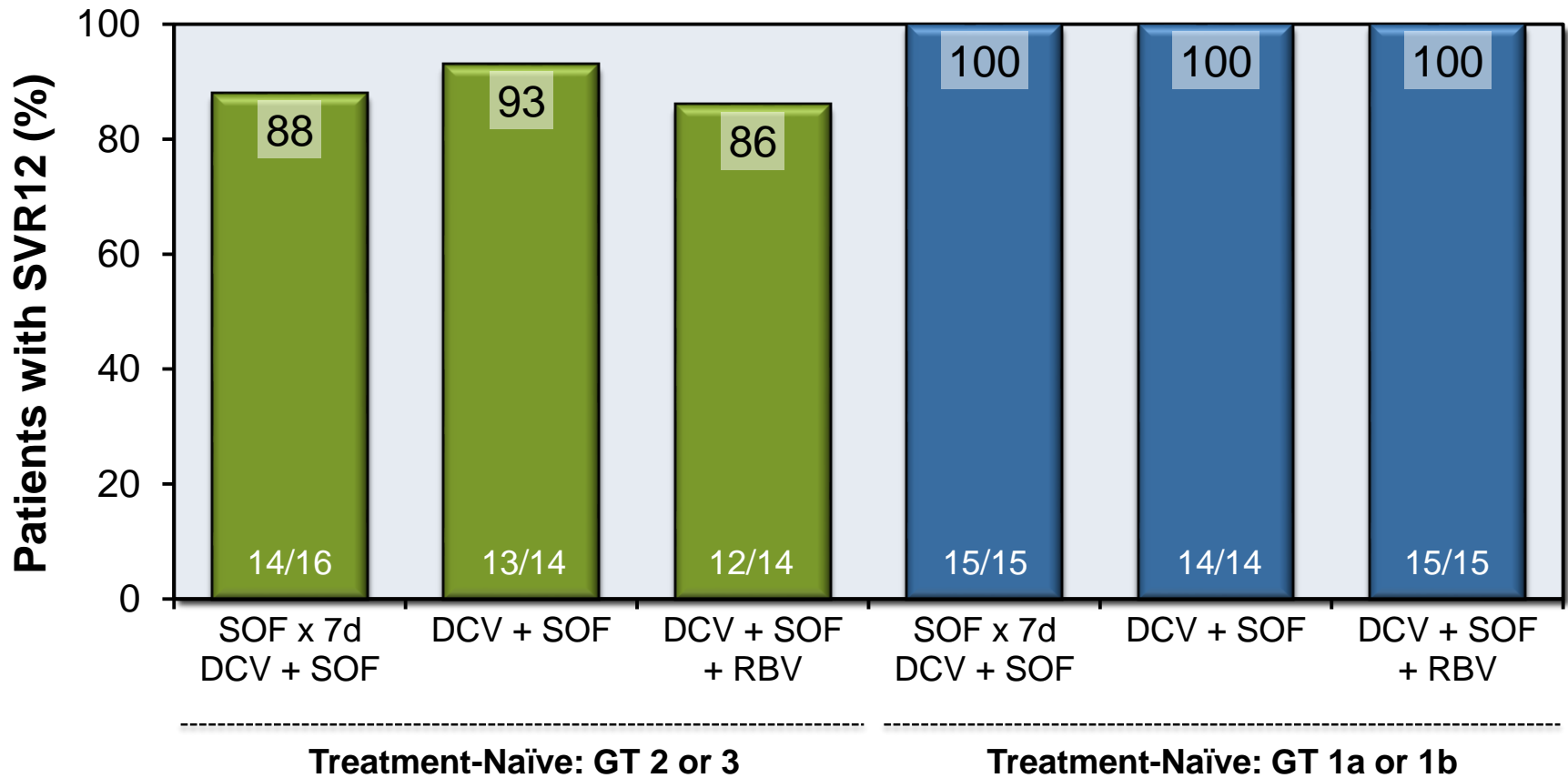

DCV = daclatasvir; SOF = sofosbuvir; RBV = ribavirin

Source: Sulkowski MS, et al. N Engl J Med. 2014;370:211-21.

Daclatasvir + Sofosbuvir +/- Ribavirin for HCV GT 1-3 GT1 Treatment-Naïve & Experienced 12 Week Rx: Results

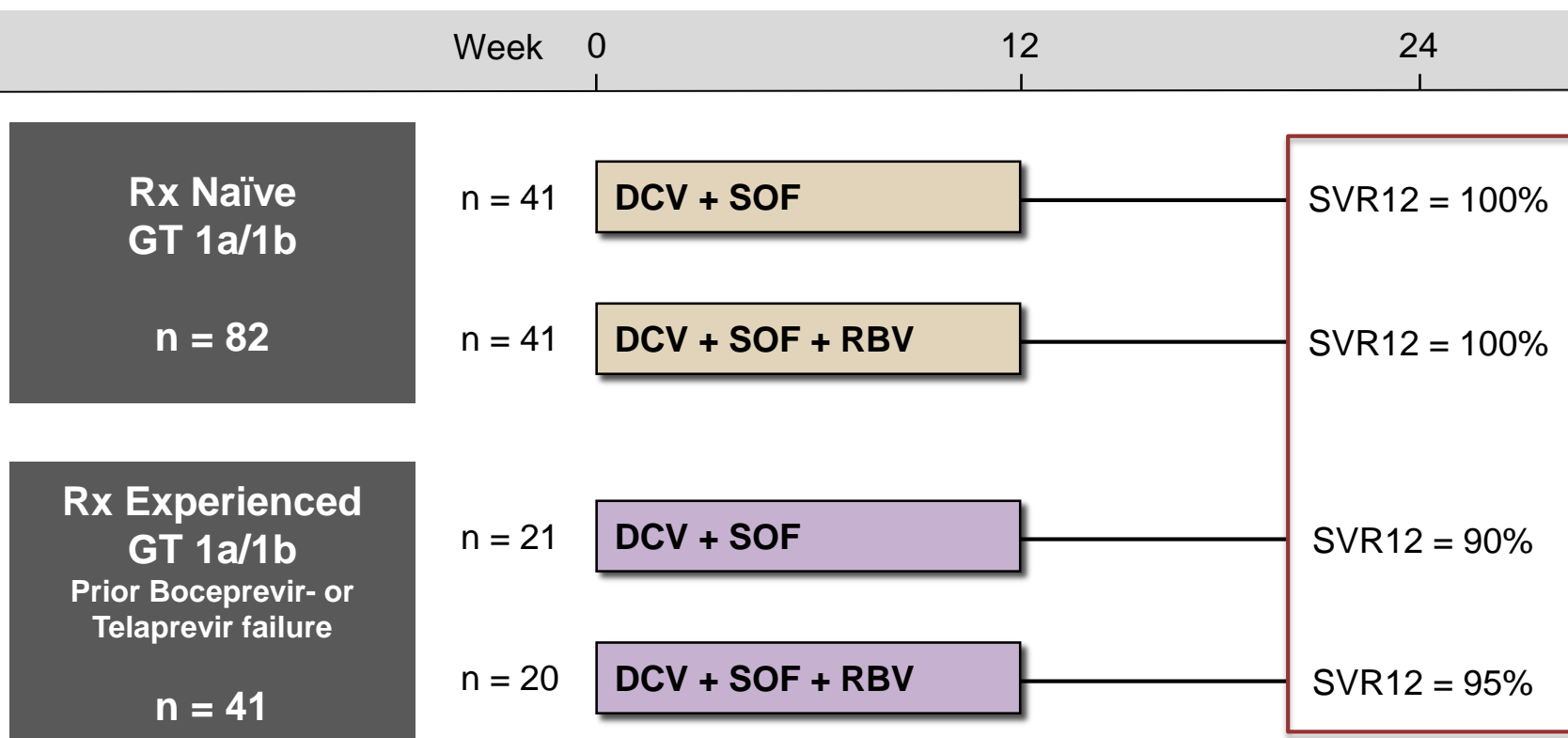

Drug Dosing

Daclatasvir (DCV): 60 mg once daily

Sofosbuvir (SOF): 400 mg once daily

Ribavirin (RBV): GT1, given weight-based and divided bid (1000 mg/day if < 75 kg or 1200 mg/day if ≥ 75 kg)

Ribavirin (RBV): GT 2,3 (800 mg/day)

Daclatasvir + Sofosbuvir +/- Ribavirin for HCV GT 1-3 GT1 Treatment-Naïve & Experienced 12 Week Rx: Results

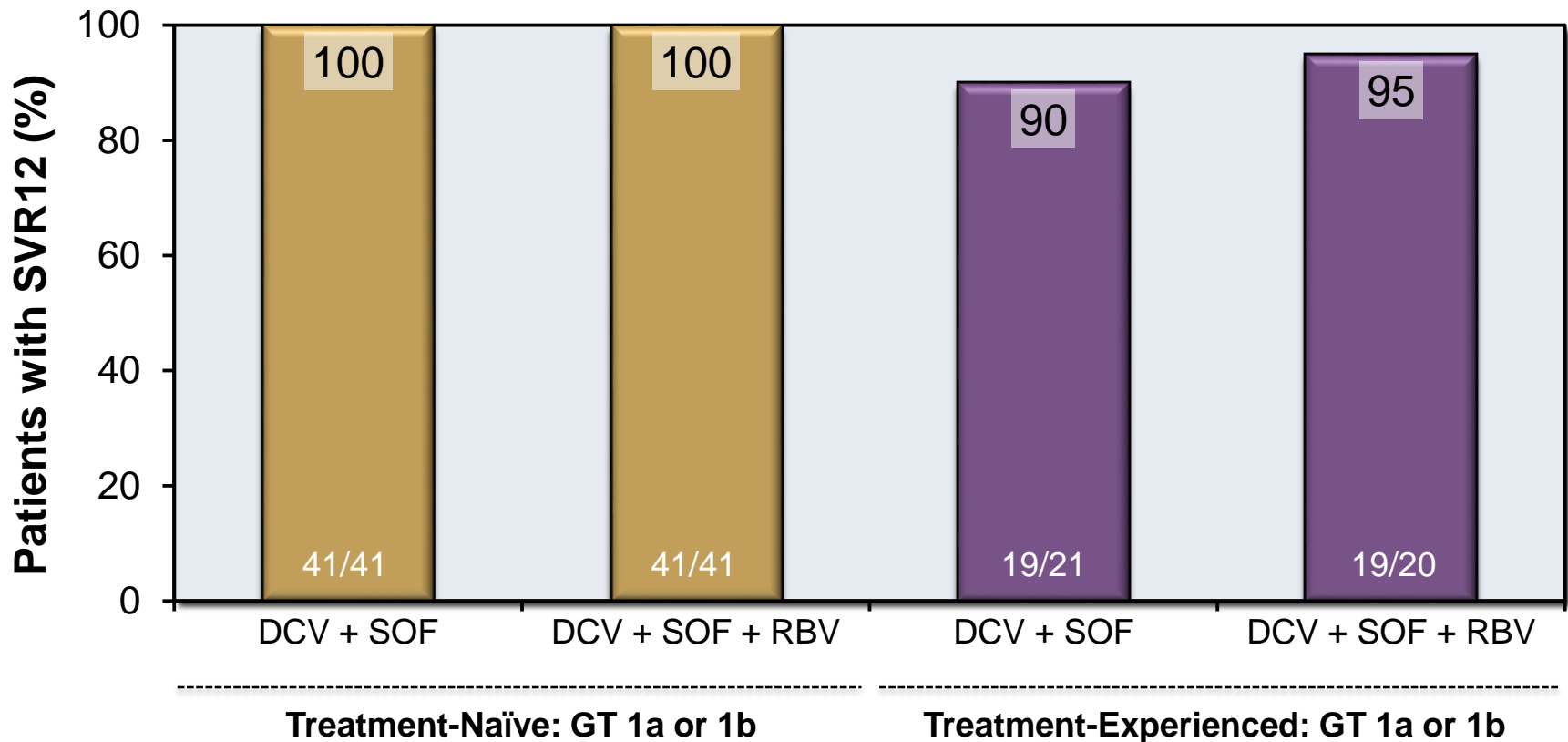

DCV = daclatasvir; SOF = sofosbuvir; RBV = ribavirin

Source: Sulkowski MS, et al. N Engl J Med. 2014;370:211-21.

Daclatasvir + Sofosbuvir +/- Ribavirin for HCV GT 1-3 Trial: Conclusions

Conclusions: “Once-daily oral daclatasvir plus sofosbuvir was associated with high rates of sustained virologic response among patients infected with HCV genotype 1, 2, or 3, including patients with no response to prior therapy with telaprevir or boceprevir.”

This slide deck is from the University of Washington's *Hepatitis C Online* and *Hepatitis Web Study* projects.

Hepatitis C Online

www.hepatitisc.uw.edu

Hepatitis Web Study

<http://depts.washington.edu/hepstudy/>

Funded by a grant from the Centers for Disease Control and Prevention.